

XIEGU

HF/50MHZ Portable Short-wave Transceiver

X5105

Operation Manual



V3.0 Preview Edition

Content

<table border="0" style="width: 100%;"> <tr><td>Basic characteristics</td><td style="text-align: right;">2</td></tr> <tr><td>Panel keys</td><td style="text-align: right;">3</td></tr> <tr><td>Left interface</td><td style="text-align: right;">6</td></tr> <tr><td>Right interface</td><td style="text-align: right;">7</td></tr> <tr><td>Handheld microphone function</td><td style="text-align: right;">8</td></tr> <tr><td>Description for external interfaces</td><td style="text-align: right;">9</td></tr> <tr><td>Charging and maintenance of build-in battery</td><td style="text-align: right;">10</td></tr> <tr><td>Connection of external power supplies</td><td style="text-align: right;">12</td></tr> <tr><td>Menu operation</td><td style="text-align: right;">14</td></tr> <tr><td> Panel keys</td><td style="text-align: right;">15</td></tr> <tr><td> Multi-function menu</td><td style="text-align: right;">17</td></tr> <tr><td> Transceiver start and shutdown</td><td style="text-align: right;">34</td></tr> <tr><td> Battery level/voltage indication</td><td style="text-align: right;">35</td></tr> <tr><td> Selection of working frequency range</td><td style="text-align: right;">36</td></tr> <tr><td> Selection of working mode (MODE)</td><td style="text-align: right;">37</td></tr> <tr><td> Volume adjustment</td><td style="text-align: right;">38</td></tr> <tr><td> Adjustment of transmitting power (Po)</td><td style="text-align: right;">39</td></tr> <tr><td> Use of PTT key of the device</td><td style="text-align: right;">40</td></tr> <tr><td> Working frequency settings</td><td style="text-align: right;">41</td></tr> <tr><td> Automatic antenna tuner (ATU)</td><td style="text-align: right;">42</td></tr> <tr><td> Fine tuning of received frequency (RIT)</td><td style="text-align: right;">43</td></tr> <tr><td> Automatic gain control (AGC)</td><td style="text-align: right;">44</td></tr> <tr><td> Pre-amplification/front attenuation (ATT)</td><td style="text-align: right;">45</td></tr> <tr><td> SPL and VFO settings</td><td style="text-align: right;">47</td></tr> <tr><td> VFO/MEMO mode switch</td><td style="text-align: right;">48</td></tr> </table>	Basic characteristics	2	Panel keys	3	Left interface	6	Right interface	7	Handheld microphone function	8	Description for external interfaces	9	Charging and maintenance of build-in battery	10	Connection of external power supplies	12	Menu operation	14	Panel keys	15	Multi-function menu	17	Transceiver start and shutdown	34	Battery level/voltage indication	35	Selection of working frequency range	36	Selection of working mode (MODE)	37	Volume adjustment	38	Adjustment of transmitting power (Po)	39	Use of PTT key of the device	40	Working frequency settings	41	Automatic antenna tuner (ATU)	42	Fine tuning of received frequency (RIT)	43	Automatic gain control (AGC)	44	Pre-amplification/front attenuation (ATT)	45	SPL and VFO settings	47	VFO/MEMO mode switch	48		<table border="0" style="width: 100%;"> <tr><td>Key lock/backlight off Lock</td><td style="text-align: right;">49</td></tr> <tr><td>CW communication</td><td style="text-align: right;">50</td></tr> <tr><td>Preset message editing and sending</td><td style="text-align: right;">51</td></tr> <tr><td>Channel manager</td><td style="text-align: right;">52</td></tr> <tr><td> Data communication by connecting with computer</td><td style="text-align: right;">53</td></tr> <tr><td>System parameter configuration</td><td style="text-align: right;">54</td></tr> <tr><td>Computer control instructions</td><td style="text-align: right;">56</td></tr> <tr><td>Wave band voltage data</td><td style="text-align: right;">56</td></tr> <tr><td>Indicators</td><td style="text-align: right;">57</td></tr> <tr><td>Attached items</td><td style="text-align: right;">57</td></tr> <tr><td>Schematic diagram of connection between existing models of Xiegu and XPA125/125B</td><td style="text-align: right;">59</td></tr> <tr><td>Schematic diagram of CE-19 expansion card interface</td><td style="text-align: right;">60</td></tr> </table>	Key lock/backlight off Lock	49	CW communication	50	Preset message editing and sending	51	Channel manager	52	Data communication by connecting with computer	53	System parameter configuration	54	Computer control instructions	56	Wave band voltage data	56	Indicators	57	Attached items	57	Schematic diagram of connection between existing models of Xiegu and XPA125/125B	59	Schematic diagram of CE-19 expansion card interface	60
Basic characteristics	2																																																																											
Panel keys	3																																																																											
Left interface	6																																																																											
Right interface	7																																																																											
Handheld microphone function	8																																																																											
Description for external interfaces	9																																																																											
Charging and maintenance of build-in battery	10																																																																											
Connection of external power supplies	12																																																																											
Menu operation	14																																																																											
Panel keys	15																																																																											
Multi-function menu	17																																																																											
Transceiver start and shutdown	34																																																																											
Battery level/voltage indication	35																																																																											
Selection of working frequency range	36																																																																											
Selection of working mode (MODE)	37																																																																											
Volume adjustment	38																																																																											
Adjustment of transmitting power (Po)	39																																																																											
Use of PTT key of the device	40																																																																											
Working frequency settings	41																																																																											
Automatic antenna tuner (ATU)	42																																																																											
Fine tuning of received frequency (RIT)	43																																																																											
Automatic gain control (AGC)	44																																																																											
Pre-amplification/front attenuation (ATT)	45																																																																											
SPL and VFO settings	47																																																																											
VFO/MEMO mode switch	48																																																																											
Key lock/backlight off Lock	49																																																																											
CW communication	50																																																																											
Preset message editing and sending	51																																																																											
Channel manager	52																																																																											
Data communication by connecting with computer	53																																																																											
System parameter configuration	54																																																																											
Computer control instructions	56																																																																											
Wave band voltage data	56																																																																											
Indicators	57																																																																											
Attached items	57																																																																											
Schematic diagram of connection between existing models of Xiegu and XPA125/125B	59																																																																											
Schematic diagram of CE-19 expansion card interface	60																																																																											

Basic Characteristics

X5105 is a kind of ultra-portable short-wave full-mode transceiver that integrates all functions required by short-wave amateur radio operations and realizes portable/mobile use of short-wave equipment in the real sense. Its strong functions and performance make you easily deal with various states in communications and hear signals from all over the world.

- ✧ HF+50MHz full-mode 5W output
- ✧ Small size (about 168*93*47mm), which is portable
- ✧ 3.6-inch large dot matrix LCD
- ✧ Built-in large capacity lithium battery pack (3800mAh @ 12V)
- ✧ Built-in efficient automatic antenna tuner
- ✧ Built-in digital baseband, which can achieve many advanced functions:
 - Digital noise reduction, digital NOTCH
 - Digital EQ equalizer
 - Variable bandwidth digital filter
 - Direct-decoding amateur radio common data mode
 - Capable of directly finishing data communication based on an external adapter without PC or separate modem
 - CW, PSK, RTTY automatic decoding/preset message transmitting
- ✧ Built-in high-stability TCXO
- ✧ Manual/auto telegram key mode switch
- ✧ Wide working voltage range

Please read this manual carefully for a better experience and full understanding on operation of the X5105.

Panel Keys

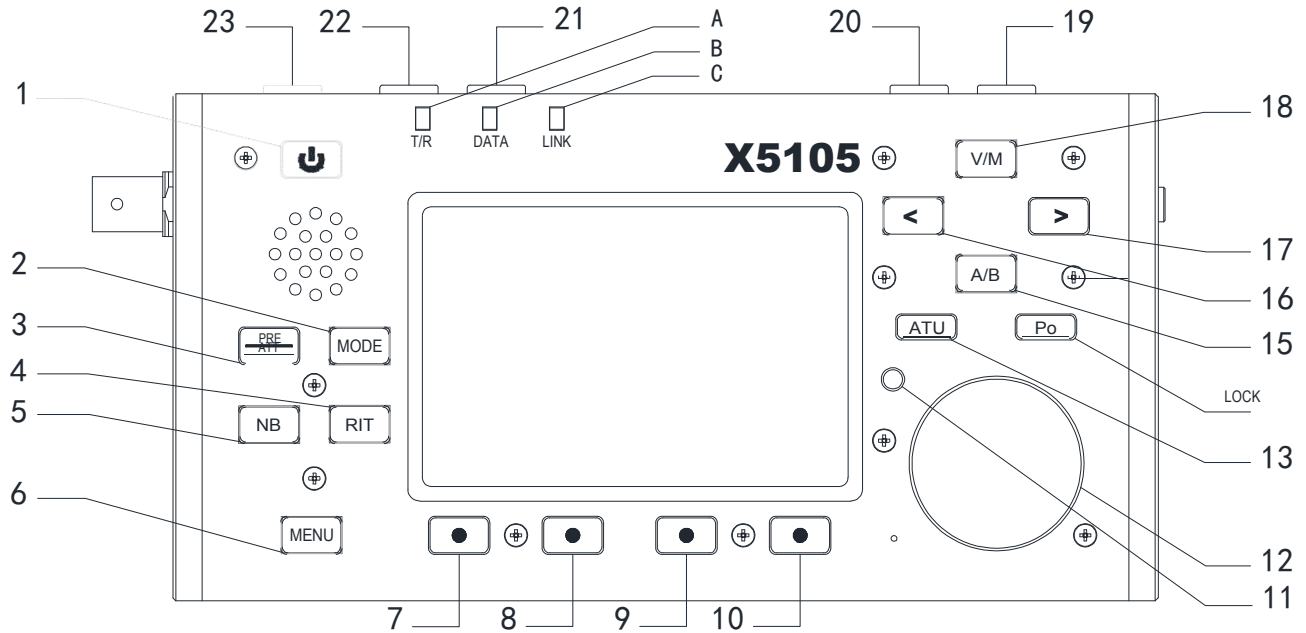

Panel Keys

1 Power switch

Press the key in a long time to turn on or turn off the radio.

2 MODE key

Press the key in a short time to change current working mode and cycle in following sequence:

[LSB-USB-CW-CWR-NFM-AM]

3 PRE/ATT key

Press the key in a short time to turn on or turn off pre-amplifier or pre-attenuator as following conditions:

[PRE=ON---ATT=ON---PRE/ATT=OFF]

4 RIT key

Press the key in a short time to enable RIT function.

5 NB key

Press the key in a short time to enable or disable NB function.

Press the key in a long time to switch the battery level/voltage indication.

6 MENU key

Press the key in a short time to switch current multi-function menu.

7~10 multi-function menu keys

Press these four keys a short time to enable or disable corresponding functions displayed in menu area on current screen.

11 LOCK key

Press the key in a short time to lock actions of all keys and knobs on panel;

Press the key for 1s to turn on or turn off backlight of display screen.

12 Major knobs (large thumbwheel)

Major tuning knobs of radio can not only be used to adjust frequency, but also can be used to set parameters.

13 ATU key

Press the key in a short time to connect built-in automatic antenna tuner to antenna port, and press the key in a long time to start the automatic antenna tuner for tuning.

14 Po key

Press the key in a short time to adjust transmitting power under the cooperation of major tuning knob. The adjustment range is 0.1W~5W.

15 A/B key

Press the key in a short time to switch between VFOA/VFOB.

16 < key

Press the key in a short time to move the stepping position of current frequency to left.

17 > key

Press the key in a short time to move the stepping position of current frequency to right.

18 V/M key

Press the key in a short time to switch between VFO mode and MEMO mode.

19 UP key

Press the key in a short time to switch to a higher frequency band.

20 DN key

Press the key in a short time to a lower frequency band.

Panel Keys

21 Volume- key

Press the key in a short time to reduce current volume.

22 Volume+ key

Press the key in a short time to increase current volume.

23 PTT key

The radio will enter transmitting state by pressing and holding the key.

A T/R indicator light

It is green when under receiving state

It is red under transmitting state

The light will be red when charging under shutdown state. It will be green when charging if finished.

B DATA indicator light

It will be flickering under data communication state.

C LINK indicator light

The light will be turned on when main machine is connected with peripherals.

Left Interface

24 Antenna interface

BNC type interface with impedance being 500.

25 Medium frequency signal outlet

Output and receive first medium frequency signals. 26 Left bracket

Stretch it outward when using it. Fold side backplate when it is not used.

27 Earphone interface

It is a 3.5mm stereo socket (3 wires) interface used to connect earphone devices.

** It shall be noted that functions of the interface will be different as for different version of X5105.*

28 DC power interface

It is an external DC power input interface used to connect external DC power by using attached power lines. External DC power supply shall be capable of supplying power output of 13.8V@3A. The interface can be also used to charge build-in battery.

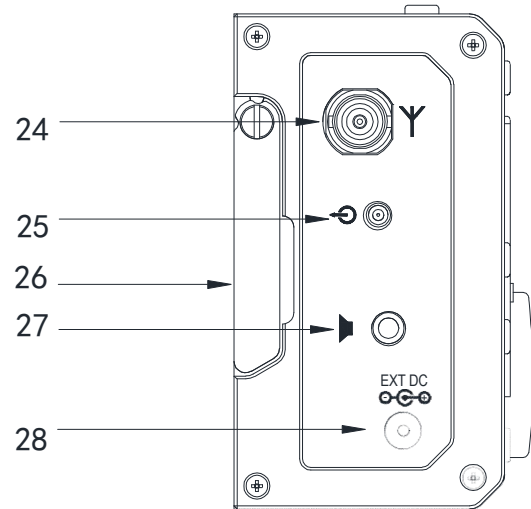

Right Interface

29 ACC interface

The interface is an 8-core mini-type DIN interface which can be used for external amplifier connection, PTT control and band signal transmission, and it can be used to input/output acoustic signal under data communication state.

30 KEY interface

It is a 3.5mm stereo interface used to connect manual/auto telegram keys. Wire connection of telegram keys are shown below:

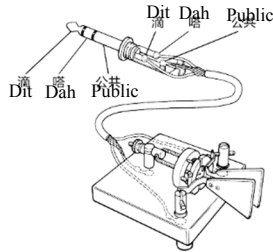

As for manual telegram key, 'Dit' and 'Dah' shall be connected together.

31 ATU interface

It is a 3.5mm interface (3 wires) used to control external antenna tuner.

*The interface functions are not opened temporarily.

32 COM interface

It is a 3.5mm interface (3 wires) used to connect computer aided control system and firmware update.

33 Right bracket

Stretch it outward when using it. Fold side backplate when it is not used.

34 MIC (microphone) interface

It is used to connect attached multi-function handheld microphone.

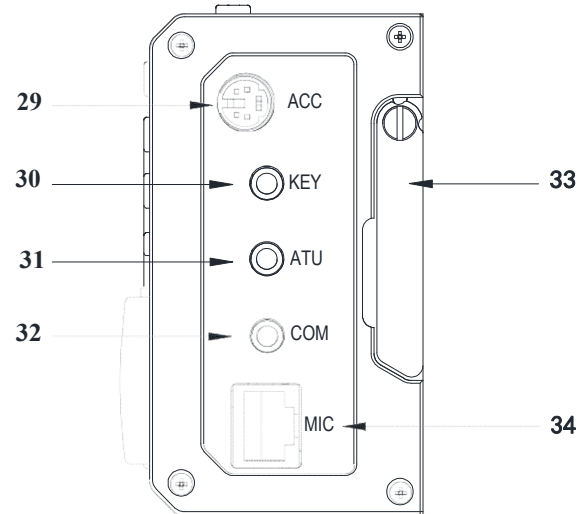

Handheld Microphone Function

- | | |
|--------------------------------|---|
| 1. LOCK key | Lock key |
| 2. PTT key | transmitting control key |
| 3. Up/down | Frequency increase/decrease key |
| 4. Transceiver indicator light | Hand microphone operation indicator light |
| 5. Figure key area | Figure keyboard area |
| 6. FIL key | Filter selection |
| 7. MODE key | Selection of working mode of main machine |
| 8. Functional indicator light | No |
| 9. Function keys | F1/F2 custom settings key |
| 10. MW key | Storage |
| 11. V/M key | Frequency/channel switching |
| 12. XFC key | Send preset message |
| 13. TUNER key | Press it in a long time to start antenna tuner for tuning |

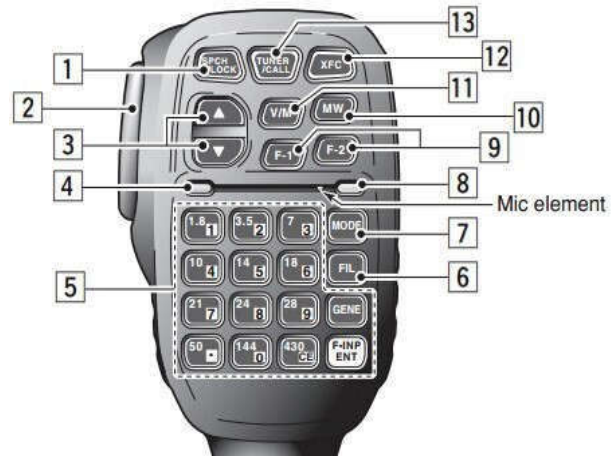

Description for External Interfaces

1、 Microphone interface

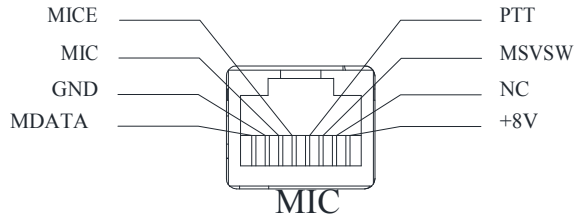

2、 CIV interface

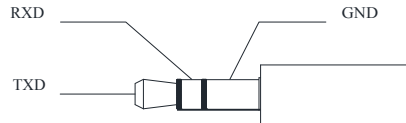

3、 Earphone interface

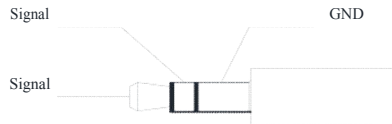

4、 ACC interface

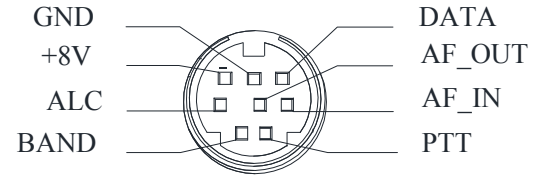

5、 Wire connection of telegram keys

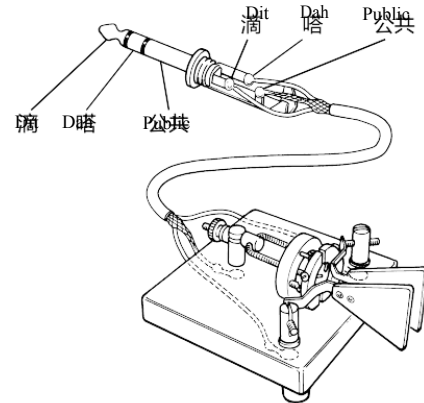

Charging and Maintenance of Build-in Battery

X5105 has a built-in 3800mAh polymer lithium battery pack. When there is no external power supply connected, the battery pack will supply power for the whole device. When external power supply is provided, the built-in circuit will be automatically switched to the external power supply.

Charging method:

1. Enter system menu #9:Charger;
2. Rotate large knob and select 'ON', and then enable charging function;
3. Select 'OFF' to disable charging function when operating.
4. Set voltage of external power supply between 13.5V~15.0V and connect to the power supply port of external power source, and then the main machine will be automatically charged.

Note: X5105 will be automatically charged and T/R indicator light will be red when charging function is enabled and connected with appropriate external power supply under shutdown state. T/R indicator light will be green when charging is finished.

5. The maximum charging time is 10-12h. Charging will be automatically stopped when battery is fully charged, and the screen will display charging finishing information as shown in right figure.

Voltage of battery is generally between 12.1~12.5V after charging.

Vext=13800mV
Vbat=11800mV
Charging...

Information displayed on screen when charging under shutdown state

Vext: Display voltage of external power supply
Vbat: Display current real-time voltage of battery

Vext=13800mV
Vbat=12200mV
Charge Finish

Information displayed on screen after charging

Charging and Maintenance of Build-in Battery

- When battery is supplying power and almost running out, the power indicator at top right corner of screen will display , indicating that charging shall be carried out immediately or switching to external power supply is required. It will be normal if the shell is slightly exothermic when charging.
- Service life of the built-in battery is limited under normal use. Please contact with dealer to replace battery if capacity of battery is obviously reduced or battery can not be charged (warranty period of battery is 3 months, replacement beyond the warranty period shall be paid).



Rated voltage range of equipment shall not be exceeded when applying external power supply, otherwise irreversible damages will be caused to equipment.



Once abnormal heating is found at the position close to battery on the back of shell, the equipment shall be immediately turned off and equipment shall be placed at a safe and ventilated place. Please contact us for proper disposal after confirming safety conditions.

Connection of External Power Supplies

13.8V external DC power supply is available for X5105. Current load capacity of DC power supply shall be 3A at least. Attached power lines can be used to connect to radio and DC power supply.

DC power supply shall be connected in strict accordance with following figure to avoid reverse polarity connection.

White line shall be connected with the positive pole of power supply and metal-shielded line shall be connected with negative pole of power supply.

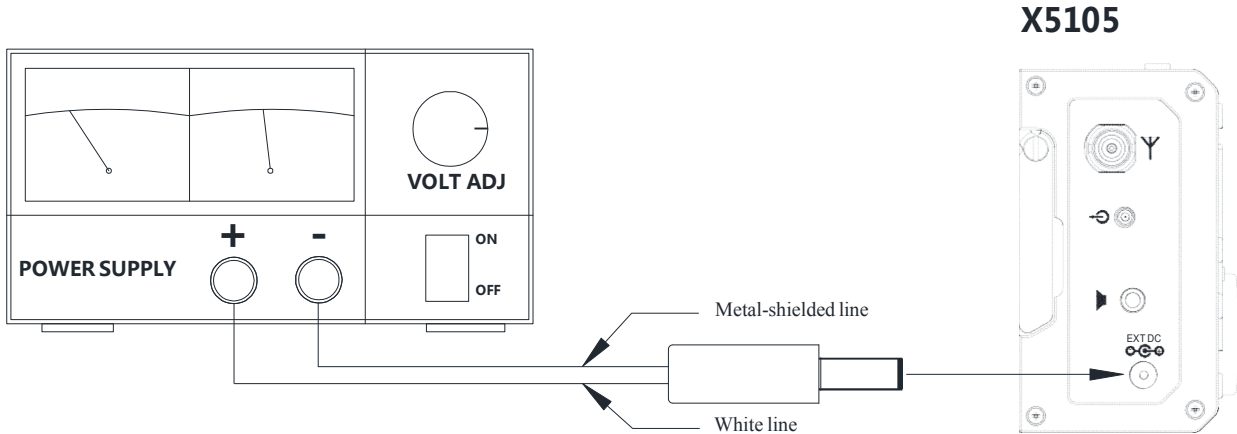

Connection of External Power Supplies

EMC magnet ring can be applied on power lines to prevent external disturbance from entering radio via power lines and radio-frequency interference in radio from radiating externally via power lines when external power supply is adopted for X5105. Magnet ring shall be installed at the side closing to battery socket.

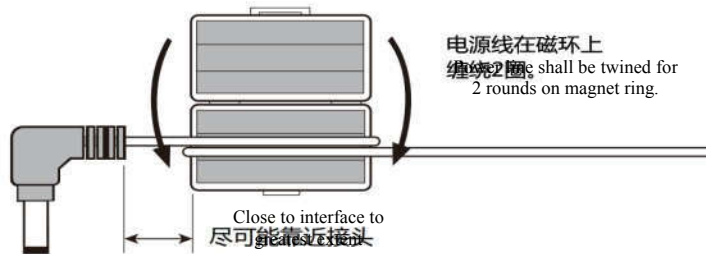

- Polarity of power lines shall be carefully inspected to avoid reverse polarity connection when external power supply is adopted.
- Limited warranty of the radio does not include damages caused by wrong connection of external power supply or abnormal voltage.

Operation

X5105 adopts multi-function menu mode to enable or disable various functions. All functions are distributed in 9 menu pages, and each page of menu has four functions that can be selected.

Menu can be switched in following methods:

- Press **MENU** key in a short time to switch menu pages.

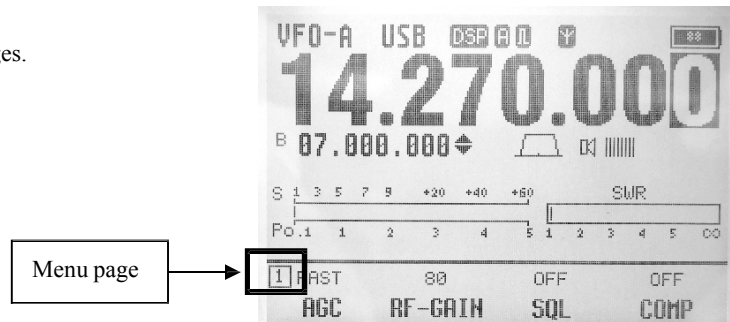

Four multi-function keys under the screen are corresponding to displayed function menu.

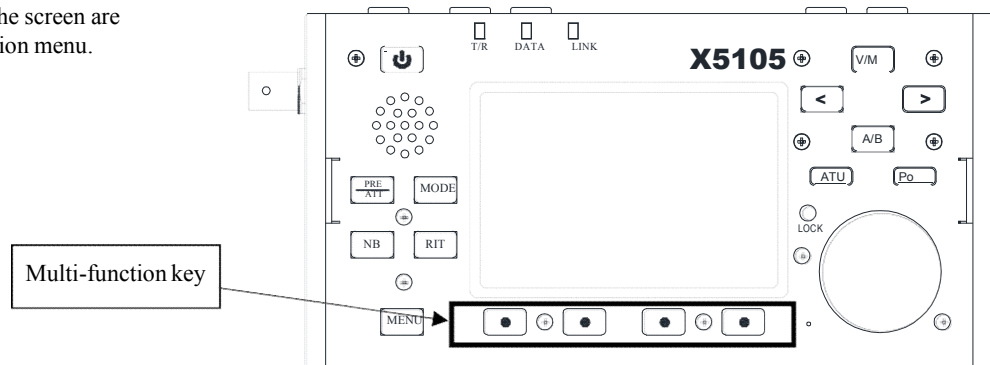

Operation

Description for functions of keys on panel

S/N	Name of keys	Operation	
		Short press	Long press
1	PTT	Depend on PTT mode settings (assume that current frequency band is allowed to be transmitted): Normal PTT mode: press to enter transmitting state and loose to enter receiving state PTT triggering mode: switch between receiving and transmitting after every press	
2	Increase volume (a large loudspeaker icon)	Increase 1 receiving volume	Continuous increase of receiving volume until loosening the key
3	Decrease volume (a small loudspeaker icon)	Decrease 1 receiving volume	Continuous decrease of receiving volume until loosening the key
4	DN	Last wave band (progressive decrease of frequency)	No
5	UP	Next wave band (progressive increase of frequency)	No
6	PWR	None	Power ON/OFF
7	PRE/ATT	Bypass PRE ON ATT ON Cycle	Not available
8	MODE	Mode LSB/USB/CW/CWR NFM/AM Cycle	SPLT on/off Cycle
9	NB	Impulse noise suppressor On/Off Cycle	Switch battery gauge/voltmeter to circularly display them

Operation

10	RIT	RIT selected/not selected Cycle	RIT value zeroing (no matter whether RIT is selected or not)
11	V/M	Switch VFO/MEMO mode Cycle	write current MEMO parameters in VFO and return to VFO mode if under MEMO mode
12	<	VFO mode: move frequency stepping position to left MEMO mode: last channel	Execute short press operation continuously Interval is about 0.1s Until loosening the key
13	>	VFO mode: move frequency stepping position to right MEMO mode: next channel	Execute short press operation continuously Interval is about 0.1s Until loosening the key
14	A/B	Switch VFO A/B Cycle	Copy foreground VFO parameters to background VFO
15	ATU	Cycle of ATU bypass/access switch	Start ATU Enable access state after adjustment
16	PO	Cycle of output power selected/not selected	Set SWR protection threshold
17	LOCK	Cycle of switch displayer backlight level (6 levels)	Keys and thumbwheel on lock panel

Operation

Functions of each page in multi-function menu are distributed as follows:

Menu page	Functions			
1	AGC	RF-GAIN	SQL	COMP
	AGC speed selection	Receiving radio frequency gain adjustment	Squelch	Voice compression
2	DSP-FLT	NR	NOTCH	EQ
	DSP options	Digital noise reduction options	NOTCH options	EQ options
3	MEMO	MSG	CALLSIGN	/
	Storage options	Preset message	Start call number settings	/
4	KEY	TONE	QSKTIME	QSK
	Options of telegram keys	Sidetone settings	Insertion time settings	Insertion settings
5	/	DIGI	SRM	SWR
	/	Digital communication decoder options	Scanning receiver options	Standing-wave scanner options
6	MIC/VOX	S/P	LIN/OUT	PTT
	MIC options	Loudspeaker/earphone options	Wire output/input options	PTT triggering mode selection

Operation of multi-function menu shall be completed under the cooperation of MENU key and major knob:

- | | |
|---|---|
| <ul style="list-style-type: none"> ■ Press MENU key in a short time: ■ Adjustment of functional parameters: ■ Enter secondary menu of a certain function: ■ Exit secondary menu | <ul style="list-style-type: none"> Page flip Rotate major knob Press the multi-function key corresponding to the function in a long time Press MENU key in a short time |
|---|---|

Menu page: 1

1 (common functions)

Key labels Functions	AGC	RF-GAIN	SQL	COMP
Short press	OFF SLOW FAST AUTO Cycle	Select radio frequency gains. Flickering when selected Rotate thumbwheel to adjust parameters	Select noise threshold Flickering when selected Rotate thumbwheel to adjust parameters	OFF ON Cycle
Long press	No	Restore defaults	No	Enter 1-4 submenu

Description of key functions:

AGC: Selection of automatic gain control speed

RF-GAIN: Receive gain settings **SQL**

: Noise threshold settings

COMP: Voice compression settings

LEVEL: Voice compression ratio settings

Operation

1-4 submenu

Key labels Functions	COMP	LEVEL	/	/
Short press	OFF ON Cycle	Select compression ratio Flickering when selected Rotate thumbwheel to adjust parameters		
Long press	No	Restore defaults	/	/

Menu page: 2**2 (DSP related)**

Key labels Functions	DSP-FIL	NR	NOTCH	EQ
Short press	OFF ON Cycle	OFF ON Cycle	OFF ON Cycle	OFF ON Cycle
Long press	Enter 2-1 submenu	Enter 2-2 submenu	Enter 2-3 submenu	Enter 2-4 submenu

Description of key functions:

- DSP-FIL:** Digital filter function settings
NR: Digital noise reduction settings
NOTCH: Digital NTH settings
EQ: Equalizer settings

#2 submenu list

2-1 (parameter adjustment of band-pass filter)

Key labels / Functions	DSP-FIL	L-CUT	H-CUT	No
Short press	OFF ON Cycle	Select filter low. Flickering when selected, Rotate thumbwheel to adjust Parameters	Select filter high. Flickering when selected, Rotate thumbwheel to adjust Parameters	No
Long press	Return to 2 main menu	Default	Default	No

#2-2 (NR parameter adjustment)

Key labels / Functions	NR	LEVEL	No	No
Short press	OFF ON Cycle Toggle NR ON/OFF	Noise selected/not selected Depth Flickering when selected Rotate thumbwheel to adjust Parameters	No	No
Long press	Return to 2 main menu	Default	No	No

#2-3 (NOTCH parameter adjustment)

Key labels Functions	NOTCH	CNT	BW	No
Short press	OFF ON Cycle	Notch selected/not selected Frequency point Flickering when selected Rotate thumbwheel to adjust Parameters	Notch selected/not selected Bandwidth Flickering when selected Rotate thumbwheel to adjust Parameters	No
Long press	Return to 2 main menu	Default	Default	No

#2-4 (EQ parameter adjustment)

Key labels Functions	BASS	MEDI	TREB	EQ
Short press	Bass selected/not selected Flickering when selected Rotate thumbwheel to adjust parameters	Alto voice selected/not selected Flickering when selected Rotate thumbwheel to adjust parameters	High-pitched voice selected/not selected Flickering when selected Rotate thumbwheel to adjust parameters	OFF ON Cycle
Long press	Default	Default	Default	Return to 2 main menu

Menu page: 3**3 (memorizer related)**

Key labels Functions	MEMO	MSG	CALLSIGN	No
Short press	Enter 3-1 submenu	Enter 3-2 submenu	Enter 3-3 submenu	No
Long press	No	No	No	No

Description of key functions:

MEMO: Storage channel settings

MSG: Preset message list editing

CALLSIGN: Boot screen call number editing

#3 submenu list**#3-1 (channel manager)**

Key labels Functions	SEL	INS	BACK	SAVE
Short press	Select CH Select TAG Cycle	Insert a letter to TAG. It is only valid when TAG is selected	When CH is selected: Deletion line will be displayed above channel contents after deleting current channel, and then it will be valid after pressing SAVE. When TAG is selected: Delete a character from the end.	Save and exit
Long press	No	No	No	No

Note: press MENU key in a short time to abort all changes and return to 3 main menu.

#3-2-1 (list of preset messages)

Key labels T Functions	QUI	EDIT	DEL	No
Short press	Exit	Edit currently selected preset messages.	Delete currently selected preset messages. Confirmation prompt: YES: confirm deletion NO: abort deletion	No
Long press	No	No	No	No

#3-2-2 (preset messages list editor)

Key labels CE Functions	SPA	INS	BACK	SAVE
Short press	Insert a space at the position where cursor is	Insert currently selected characters at the position where cursor is	Delete a character at the position where cursor is	Save and exit
Long press	Insert 'DE+space'	Insert call number +space (if customized call number exists)	Insert 'CQ+space'	No

Note: press MENU key in a short time to abort all changes and return to 3 main menu. Length of each preset message is 100 English characters.

#3-3 (call number editor)

Key labels Functions	SPACE	INS	BACK	SAVE
Short press	Insert a space at the position where cursor is	Insert currently selected characters at the position where cursor is	Delete a character at the position where cursor is	Save and exit
Long press	No	No	No	No

Note: press MENU key in a short time to abort changes and return to 3 main menu.

Menu page: 4

4 (telegram keys/CW related)

Key labels Functions	KEY	TONE	QSKTIME	QSK
Short press	Manual key Auto key-left hand Auto key-right hand Cycle	Select CW sidetone. Flickering when selected, Rotate thumbwheel to adjust Parameters	Select QSK delay. Flickering when selected, Rotate thumbwheel to adjust Parameters	OFF ON Cycle
Long press	Enter 4-1 submenu	Default	Default	Default

#4 submenu list

#4-1 (parameters adjustment of telegram keys)

Key labels Functions	KEY	IAMBIC	SPEED	RATIO
Short press	Manual key Auto key-left hand Auto key-right hand Cycle	A MODE B MODE Cycle	Select auto key speed Flickering when selected Rotate thumbwheel to adjust Parameters	Select dot-and-dash interval Flickering when selected Rotate thumbwheel to adjust Parameters
Long press	Return to 4 main menu	Default	Default	Default

Menu page: 5

5 (special functions)

Key labels Functions	No	DIGI	SRM	SWR
Short press	No	Enable data mode	Start scanning receiver	Start standing-wave scanner
Long press	No	No	No	No

#5 submenu list

#5-2 (data mode)

Key labels Functions	PSK31	AFC	CAR	MSG
Short press	Select data mode PSK31, 63, 125 CWDEM, RTTY Cycle	Selected/not selected Signal frequency Rotate thumbwheel to adjust	Selected/not selected Carrier frequency Rotate thumbwheel to adjust	Select preset messages (1~10)
Long press	No	No	No	No

#5-3 (scanning receiver)

Key labels Functions	QUIT	BW	STOP	No
Short press	Exit	Switch scanning step 0.5/1/2/5/10kHz Cycle	Pause/ (Monitoring current frequency point) recover scanning Cycle	No
Long press	No	No	No	No

#5-4 (standing-wave scanner)

Key labels Functions	QUIT	BW	MODE	SPEED
Short press	Exit	Switch scanning step 1/5/10kHz Cycle	Switch scanning mode Single step/continuous Cycle	Switch scanning speed Fast/slow Cycle
Long press	No	No	No	No

Clarifications:

MODE:

- Single step: stop after every round of scanning, and then press PTT key (onboard or Hand microphone PTT) to trigger next scanning
- Continuous: continuous scanning.

SPEED:

- Fast: time interval of each scanning point is about 12ms.
- Slow: time interval of each scanning point is about 25ms.

◆ *Tips: fast speed can be switched to slow speed if the scanning curve is not stable.*

Menu page: 6**6 (interface functions)**

Key labels Functions	MIC/VOX	SPK	LIN/OUT	PTT
Short press	Auto/built-in/external Cycle	Built-in loudspeaker/ external Earphone Cycle	Enter 6-3 submenu	PTT conventional/ triggering mode Cycle
Long press	Enter 6-1 submenu	No	No	No

Clarifications:**MIC:**

AUTO: built-in microphone will be automatically selected when hand microphone is not detected, otherwise external microphone will be selected.

Built-in INT: select built-in microphone.

External EXT: select hand microphone.

★ Important notes:

When LINE IN is enabled, both built-in MIC and external MIC are not available.

#6 submenu list**#6-1 (MIC gain adjustment)**

Key labels Functions	VOX	G-VOX	GAIN-IN	GAIN-EX
Short press	On/Off Cycle	Select built-in VOX gains and rotate thumbwheel to achieve the adjustment	Select built-in MIC gains and rotate thumbwheel to achieve the adjustment	Select external MIC gains and rotate thumbwheel to achieve the adjustment
Long press	No	Default	Default	Default

Clarifications:

VOX: only LINE IN can be triggered.

No adjustment menu provided for VOX receiving and sending switching delay temporarily, and the delay is determined as 100ms.

★ Important notes:

Transmitting channel gains in different hardware versions are different. Excessive gain settings may cause large transmitting background noise under single side band mode, which can be solved by decreasing MIC GAIN.

#6-3 (line gain adjustment)

Key labels N Functions	LI	G-LIN	LOUT	G-LOUT
Short press	Line input on/off Cycle	Select line input gains and rotate thumbwheel to achieve the adjustment	Line output on/off Cycle	Select line output gains and rotate thumbwheel to achieve the adjustment
Long press	No	Default	No	Default

Clarifications:

X5105 hardware without screen protection plate has no individual LINE OUT channel. Its LINE OUT shares the same signal with audio frequency amplifier. At this time, LINE OUT/switch and LINE OUT gain have no effect, and the LINE OUT terminal of ACC interface is outputting all the time with output level related to receiving volume.

Routine operation

Transceiver start and shutdown

1. Start the transceiver: press and hold the switch key for 1s.
2. Shut down the transceiver: press and hold the switch key for 1s under startup state.

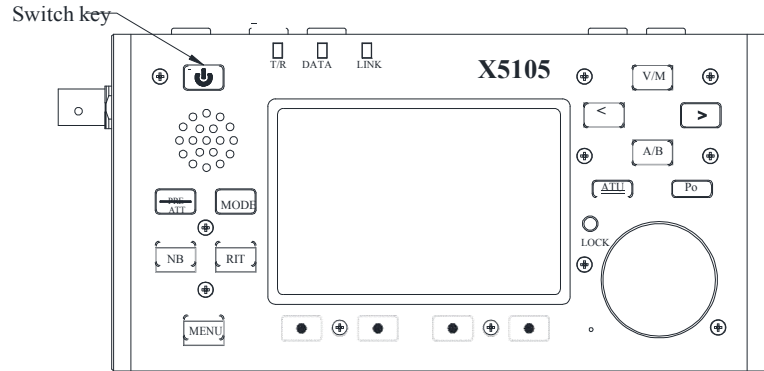

★ Important notes:

Please turn off the equipment correctly according to above method after using it. If external power supply is directly cut off, current working data can not be saved and large impact and faults will be caused to built-in power units.

- ◆ Hard reset: press and hold startup key for above 8s to reset the built-in main controller and shut the equipment down compulsively when system of main machine is crashed, such as no response of keys or failure of exiting transmitting state and keys.

Battery level/voltage indication

Press NB key to switch the battery level/voltage indication.

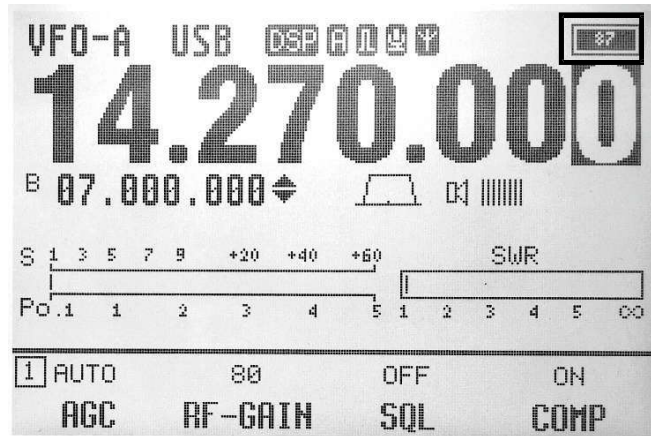

- ◆ If the X5105 transceiver is not used for more than 30 days, we suggest to connect it with an external power supply to charge it until the charging is finished. See operation instructions in [Charging] for details.

Selection of working frequency range

Frequency range of X5105 covers 0.5~54MHz. Amateur frequency in such range is divided into several frequency bands, and frequency band switch can be achieved by adopting many types of different modes.

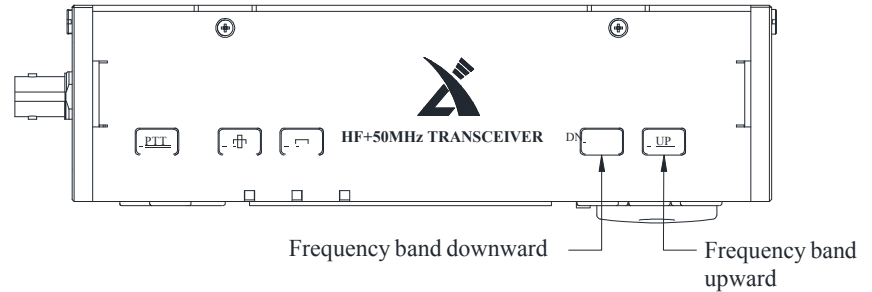

Operation methods:

Press DN or UP key to respectively switch to next or last operation frequency band.

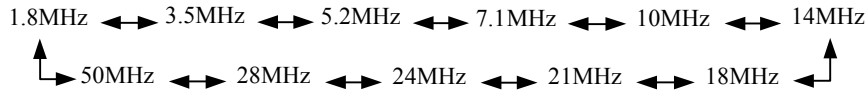

- 5MHz frequency band shall be opened according to regulations of the country (or region).
- Frequency division for equipment in different versions is different, which shall be in accordance with the regulations of the country (or region).

Operating mode selection

Press [MODE] key and follow the fixed sequence below among all modes

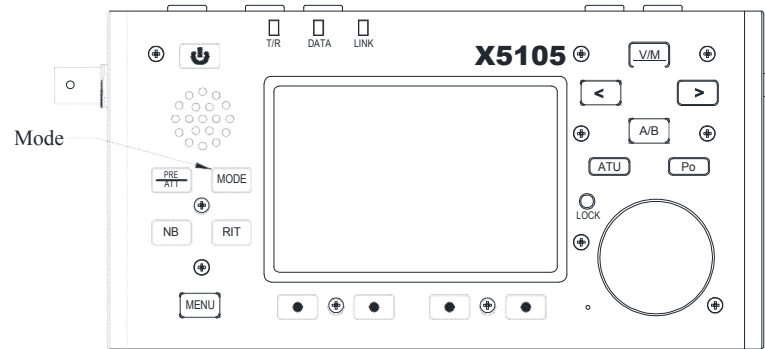
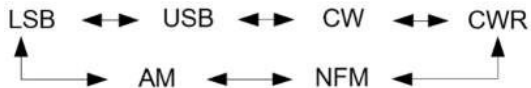

Volume adjustment

Press [volume+, -] key to adjust the output volume

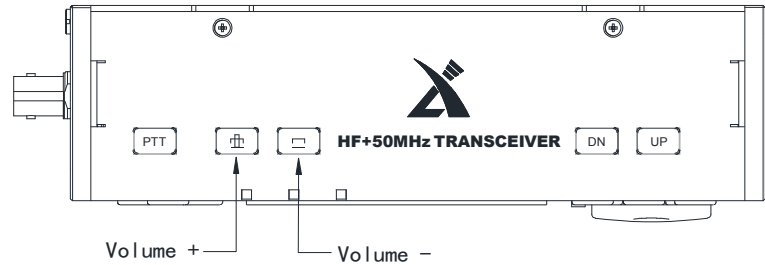

Tips:

Press volume+ or - key in a long time to continuously increase or decrease volume until loosening the key.

Adjustment of transmitting power

Press [PO] transmitting power settings

Operation methods:

1. Press [Po] key in a short time to enter power settings state, and the screen will display the Po power setting value.
2. Rotate large knob to set power within the range of 0.1W-5W.

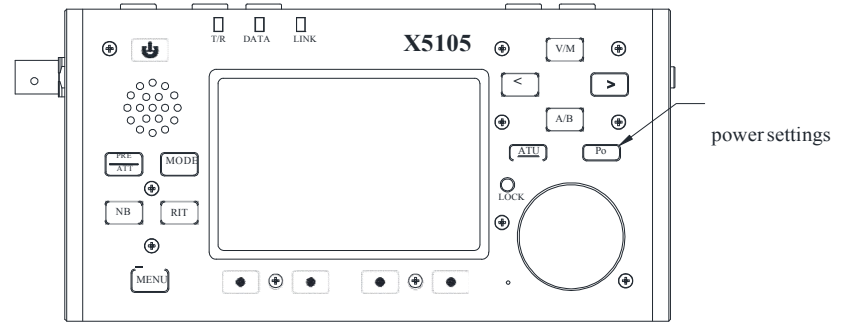

- ◆ Please minimize the preset transmitting power when using X5105 transceiver for the first time under the condition of not understanding the current state of antenna.

Use of PTT key of the device

X5105 has a build-in PTT key which can enable the transmission of transceiver.

Operation methods:

1. Press the key to enable the transmitting function of transceiver;
2. Speak to the built-in MIC hole beside the knob to complete the communication.

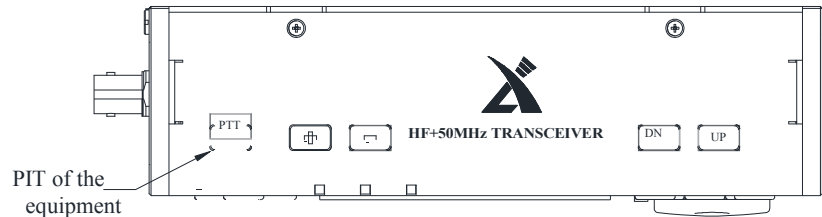

Clarifications:

There are two PTT triggering modes:

- Normal mode: press to enter transmitting state and loose to enter receiving state.
- Triggering mode: switch between receiving and transmitting after every press. See relevant contents in menu 6 for details.
- ◆ You can try to use PTT key and build-in MIC (please select INT for MIC) of the equipment and use the equipment in handheld way.

Working frequency settings

There are two methods for setting working frequency of X5105, i.e., set by

Operation methods:

1. Set frequency by using large knob

position cursor to left or right, so as to select the frequency position of

- Rotate frequency knob and set the frequency of current step.

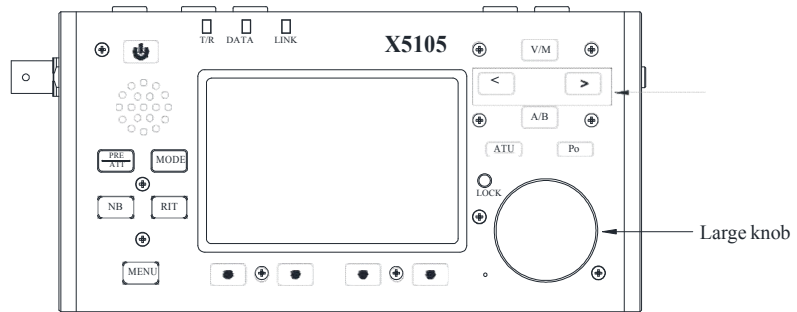

2. Set frequency by using multi-function hand microphone

- Press [F-INP ENT] key on hand microphone, and the X5105 will be in frequency setting state, and cursor will be flickering at the first place on the left of frequency display position;
- Respectively input expected frequency values, and press [F-INP ENT] key again to complete frequency settings.

For example, press keys in following sequence to set current frequency as 51.050000MHz:

1. Press [F-INP ENT] firstly;
2. Respectively press number keys;
3. Press [F-INP ENT] again to complete the settings.

ATU

transceiver to help you easily erect

- Press [ATU] key in a short time
- tuner. There will be an antenna icon at the top of screen.
- Press and hold [ATU] key for 1s to start ATU automatic tuning functions. IT will automatically return to receiving state after the tuning.

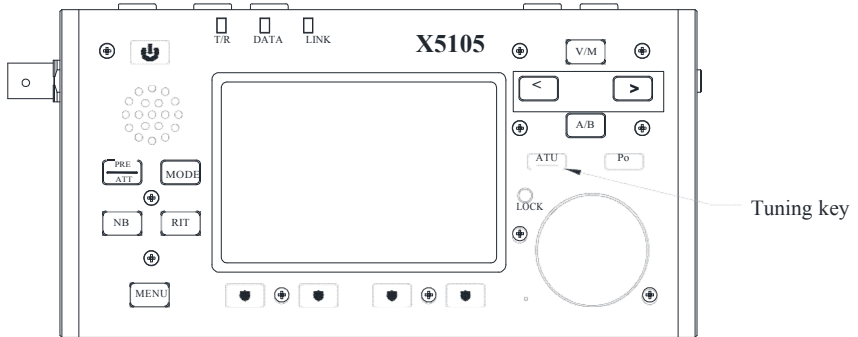

Note:

1. Press [ATU] key, and there will be an antenna icon at the top of screen, indicating that antenna tuning functions are only enabled and not working.
2. Once built-in antenna tuning is adopted, tuning shall be carried out for one time after antenna tuning function is enabled.
3. If value displayed in standing-wave meter is large once transmitting is enabled after the tuning, it indicates that standing-wave of current antenna is still large and tuning is required to be carried out again.
4. Antenna tuning shall be turned off once natural resonance of antenna reaches current frequency band.

Fine tuning of received frequency (RIT)

RIT function can set the deviation value of actual receiving frequency corresponding to set frequency, that is $\pm 1.5\text{kHz}$ at maximum.

Operation methods:

RIT function. There will be a ΔF icon on screen;

2. Rotate knob to make the frequency of receiver changes within $\pm 1.5\text{kHz}$, and the changed value of frequency will be displayed in relevant area on screen.

3. If RIT deviation value has to be reset, press and hold [RIT] for about 2s to reset the value set by RIT. Meanwhile, AF icon will disappear.

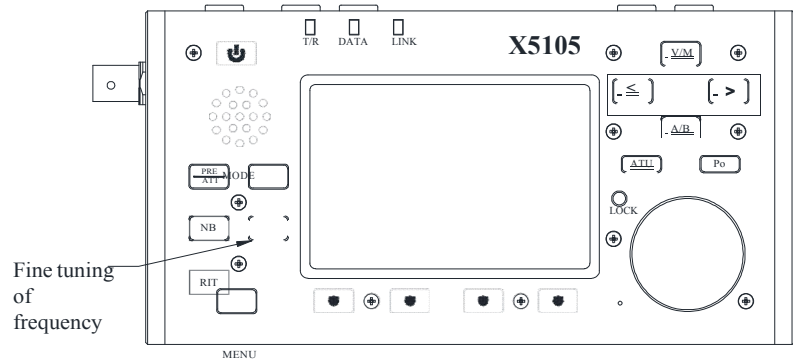

Automatic gain control (AGC)

Receiving effect can be optimized by adjusting proper AGC speed.

Operation methods:

1. Switch to menu in page 1 and press [AGC] functional key in a short time;
 2. AGC functions will be circularly selected according to following sequence:
OFF—SLOW—FAST--AUTO
 3. Optimal effect will be obtained by reasonably selecting different AGC speed according to different receiving modes.
 - SSB/AM mode: SLOW is recommended
 - CW mode: FAST if recommended
 - If AUTO is selected, main machine will be automatically switched to a corresponding control speed according to different modes.
- ◆ If 'AGC-OFF' is selected, AGC system will be closed and S meter will display nothing.

PRE/ATT

PRE and ATT can improve the listen-in effect of the receiver. When signal is weak, PRE can be turned on to improve

ATT can be turned on to reduce signal strength. You can also turn off the circuit unit to make signal feedthrough.

Operation methods:

1. Press [PRE/ATT] in a short time to enable the function.
2. Switch sequence by following the cycle below:

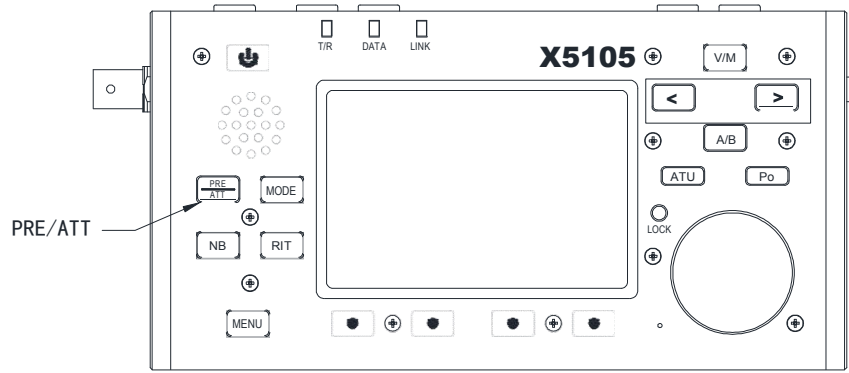
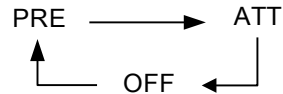

- ◆ When operation in short wave low bands (lower than 10MHz), PRE can be turned off to make signal feedthrough, which facilitates to improve the receiving effect and avoid receiver blocking caused by strong interference signal. Generally, it will be unnecessary to turn on PRE if S meter is working.

Pulse interference suppressor NB

Pulse interference suppressor can effectively eliminate some specific impulse interferences, especially the noise caused by automobile ignition system, so that receiving effect can be obviously improved.

Operation methods:

1. Press [NB] key in a short time to enable NB function, and there will be relevant prompt messages on screen.
2. Press[NB] key again to turn off NB pulse suppressor.

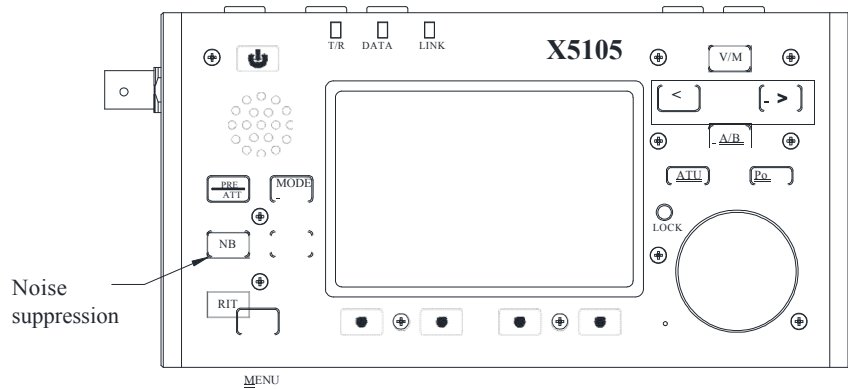

- ◆ NB function only has inhibiting effect on special impulse noises, which can not be used to replace digital noise reduction function.

Different frequency receiving and sending operation SPL and VFOA/B settings

X5105 transceiver has two built-in set different frequencies and modes. Cooperated with SPL function, it can conveniently achieve different operations.

VFO settings:

1. Press [A/B] key in a short time to switch between VFO-A and VFO-B;
2. Set current VFO working frequency and mode when switching to a certain VFO state.

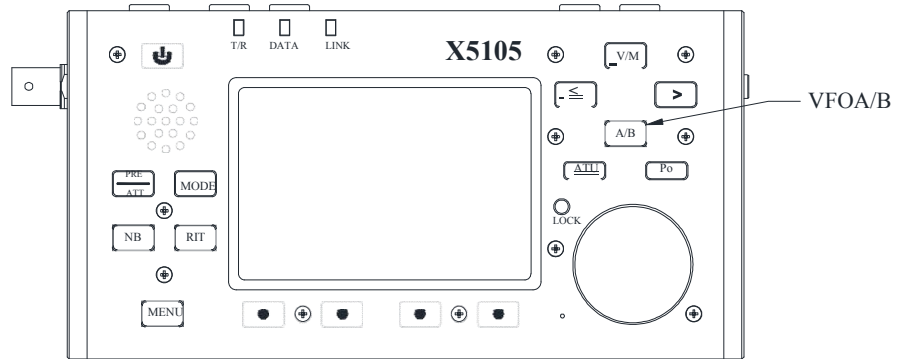

Different frequency receiving and sending SPLT operation methods:

1. Set receiving frequency and mode (VFO-A) firstly;
2. Set transmitting frequency and mode (VFO-B);
3. Press [MODE] key to enable/disable different frequency receiving and sending modes. There will be two triangle symbols on screen after enabling.

◆ VFOA/B can be fully used to set different frequencies and modes, so as to achieve raid switching between two frequency points.

VFO mode/MEMO mode switch V/M

transceiver can be switched between VFO mode and MEMO mode to achieve flexible operation method.

Operation methods:

1. Press [V/M] key in a short time to switch between VFO (frequency) mode and MEMO (channel) mode.
2. Press [V/M] key in a short timer under current mode to switch to another mode state.

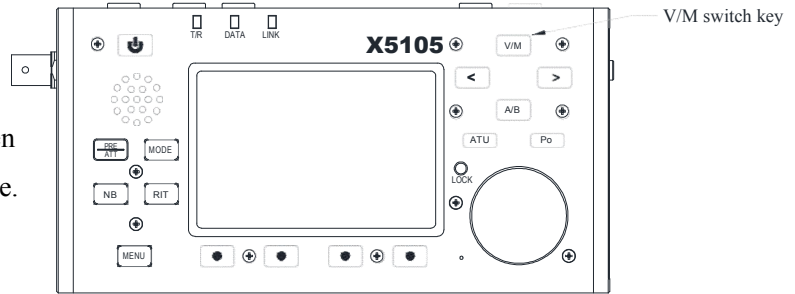

Tips:

Press [V/M] key in a long time under MEMO channel mode to write current MEMO parameters in VFO and return to VFO mode.

Key lock/backlight brightness adjustment Lock

Lock [LOCK] key to avoid spurious triggering of transceiver and hand microphone during outdoor operations. After lock function is enabled, other keys, knobs and Hand microphone keys on panel of main machine are invalid except for PTT keys and this key.

Operation methods:

1. Press [LOCK] in a long time to enable lock;

again to unlock.

3. There will be a lock symbol in relevant area of screen after locking.

4. Press [LOCK] in a short time to adjust backlight brightness (5 levels) until backlight is turned off.

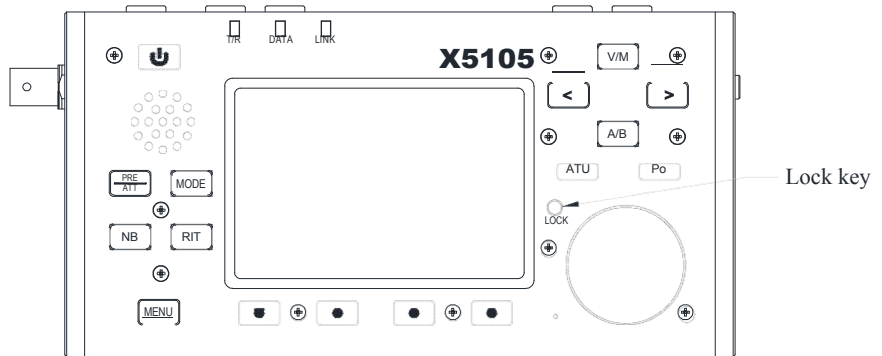

CW communication

Use manual keys or external keying unit for operations.

Operation methods:

1. Insert keys (three-wire) in KEY interface at right side of plug;
2. Press [MODE] key to switch to CW (or CWR) mode;
3. Press [MENU] key in a short time to switch to the menu in page 4, and then set parameters of relevant telegram keys and QSK.
4. Press telegram key to enable CW communication.

Trainer mode

You can take X5105 as a CW code trainer in following methods:

Press [MENU] key in a short time to switch to menu in page 4 and select QSK function as 'OFF'.

There will be CW sidetone of transceiver after pressing telegram keys under such conditions, but signals will not be transmitted externally.

Tips:

See the introduction to multi-function menu 4 for selection of telegram keys and relevant settings of auto keys or other operations.

Preset message editing and sending MSG1~MSG10

Main machine of X5105 provides a memory for 10 groups of preset telegraph texts to achieve automatic calling under CW/PSK/RTTY mode.

Operation methods:

1. See the introduction to multi-function menu 3 for details on operation and editing method of preset telegraph texts.
2. in #5-2 menu, press [MSG] key in a short time to select the telegraph texts to be sent, and then press XFC key on multi-function hand microphone to send them.

Channel manager

Channel memory (MEMO)

1. See #3-1 submenu for the operation of channel memory.
2. Press [SEL] key to select channel number to be stored.
3. Press [SAVE] to save it after selecting channel number.

Channel name TAG

4. Press [SEL] key to select TAG editing items.
5. Rotate major knob to select required characters, and then press [SAVE] to save them.
6. 3. Press V/M key on panel to see the edited channel names.

See #3 menu for other relevant operation details.

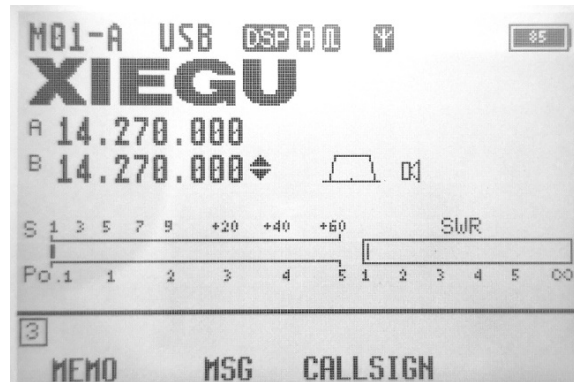

Amateur radio data communications by connecting with computer

X5105 transceiver can be connected with computer and complete all kinds of data communications under the help of computer softwares.

Operation and connection methods:

1. Connect computer audio output/input to X5105 from ACC interface (MINI-DIN8).
2. Insert attached data cable into COM (or CIV) interface, connect X5105 with computer, and ensure that drive of computer of data cable is correctly installed and PC software can control the X5105 transceiver;
3. Adjust the volume of X5105 and input/output volume of ACC interface to a proper level and observe software interface to avoid communication failure caused by excessive audio range.
4. Select corresponding working modes, i.e., carry out data communication.

◆ **Radio and computer must be well grounded to avoid interference, and EMC magnet ring shall be installed for data cable and audio cable at the position close to main machine of radio to greatest extent.**

System parameter configuration

Personalized settings can be achieved for transceiver in system settings menu to make it fit your using habit in a better way.

Operation methods:

1. Press and hold [MENU] key for 1s to enter system settings menu;
 2. Press [<] and [>] multi-function keys at the bottom of screen to call out the menu items you want to adjust;
 3. Rotate major knob to set parameters you wanted;
 4. Press [SAVE] key in a short time to save current settings and exit menu mode after setting.
- ◆ If pressing [QUIT] key in a short key in step 4 mentioned above, new settings will not be saved and the equipment will exit menu mode of the system.

Descriptions of system menu

Menu items		Function description	Settable values	Default
#1	LCD Backlight	Displayer backlight brightness	OFF ~ LEVEL5	LEVEL5
#2	LCD Contrast	Displayer contrast ratio	0 ~ 30	30
#3	BEEP Volum	System prompt volume	0 ~ 100	50
#4	CW Tone Volum	CW sidetone volume	0 ~ 100	50
#5	Key BEEP	Key prompt tone	OFF/ON	ON
#6	AM Mod Level	AM transmission modulation degree	0 ~ 63	60

System Parameter Configuration

#7	Band Stack Mode	Wave band group mode	Ham band only / Full band	Ham band only
#8	MIC Bias	Hand microphone bias settings	OFF/ON	ON
#9	Charger	Charging switch	OFF/ON	ON
#10	IF Output	Intermediate frequency output switch	OFF/ON	OFF
#11	RSSI Scale	S meter calibration		
#12	User Key F1	Hand microphone F1 key customization		LEFT
#13	User Key F2	Hand microphone F2 key customization		RIGHT

- ◆ Default parameters can ensure that the transceiver is working under a goods condition. You can also adjust above parameters in a fine way according to your using habits.

Computer control instructions

X5105 adopts standard CIV instruction sets. You can remotely control the transceiver based on standard instructions of the instruction set or configure control instructions of other softwares, so as to achieve the control on X5105.

Wave band voltage data

ACC interface of X5105 provides wave band voltage data of each frequency band. The wave band data can control peripherals to achieve automatic wave band switch or can be used by other equipment to identify wave band information.

Wave band	Voltage	Wave band	Voltage	Wave band	Voltage	Wave band	Voltage
1.8MHz	230mV	7MHz	920mV	18MHz	1610mV	28MHz	2300mV
3.5MHz	460mV	10MHz	1150mV	21MHz	1840mV	50MHz	2530mV
5.0MHz	690mV	14MHz	1380mV	24MHz	2070mV	/	/

Indicators

General parameters

Frequency range	
Receiving: 0.5MHz ~ 30MHz	50MHz ~ 54MHz
Transmitting: 1.8 ~ 2.0MHz	3.5 ~ 3.9MHz
5.3515 ~ 5.3665MHz	7.0 ~ 7.2MHz
10.1 ~ 10.15MHz	14.0 ~ 14.35MHz
18.068 ~ 18.168MHz	21.0 ~ 21.45MHz
24.89 ~ 24.99MHz	28.0 ~ 29.7MHz
50 ~ 54MHz	
Transmitting mode:	A1A(CW) , A3E(AM) , J3E(USB/LSB) , F3E(FM)
Minimum step:	1Hz
Antenna impedance:	50Ω
Working temperature range:	-10°C ~ +50°C
Frequency stability:	±4ppm @25C° within 1-60min after startup: 1ppm/h
Power voltage:	9.0~15.0VDC, cathode grounding
Current consumption:	Receiving: 600mA@ Max Transmitting: 2.5A@ Max 3800mAh @12V
Battery capacity:	168*93*47mm (WxHxT)
Size of the equipment:	(excluding protrusions)
Weight:	About 0.94kg (only main machine)
Transmitter parameters:	5W(SSB/CW/FM)
Radio frequency output power:	1.5W (AM carrier wave) @13.8VDC SSB: balanced modulation AM: Low level amplitude modulation
Modulation type:	FM: variable reactance frequency modulation
FM maximum frequency offset:	±5kHz
Stray radiation:	-55dB

Carrier suppression:	> 40dB
Sideband stray:	> 50dB
SSB frequency response:	400Hz-2800Hz (-6dB)
Microphone impedance:	200 ~ 10k ((600Ω in general)
Receiver parameters and circuit type:	Double conversion superheterodyne+audio DSP
Intermediate frequency:	First intermediate frequency: 70.455MHz Second intermediate frequency: 10.695MHz Third intermediate frequency: 455kHz(NFM)
Sensitivity:	

	SSB/CW	AM	FM
≤1.8MHz	0.6uV	10uV	/
1.8MHz-28MHz	0.25uV	2uV	/
28MHz-30MHz	0.25uV	2uV	0.35uV
50MHz-54MHz	0.25uV	2uV	0.35uV

(PRE=on , ATT=off , NB=off , NR=off , SSB/CW/AM=10dB S/N , FM=12dB SINAD)

Image rejection ratio:	70dB
Intermediate frequency suppression	SSB : -6dB:2.4kHz/-60dB:4.6kHz
degree:	CW : -6dB:500Hz/-60dB:2000Hz
Selectivity:	AM : -6dB:6.0kHz/-60dB:25.0kHz
	FM : -6dB:12.0kHz/-60dB:25.0kHz

Audio output :0.6W (8Ω,≤10% THD)
Audio output impedance: 4~16Ω

- ◆ Above specifications may be changed without notice.
- ◆ Working frequency range of transceiver varies from version of the equipment. Ask dealer for details.

Standard attached items

Items	Qty.
Main machine of X5105 (provided with batteries)	1 pcs
Multi-function hand microphone	1 pcs
Power line	1 pcs
Data cable	1 pcs
Manual	1 pcs
Quality certificate	1 pcs
Warranty card	1 pcs

*Optional accessories

Name of components	Description
CE-19	ACC expanded wiring card
XPA125B	100W power amplifier and antenna tuner AIO

Schematic Diagram of Connection between Existing Models of XIEGU and XPA125B/ XPA125

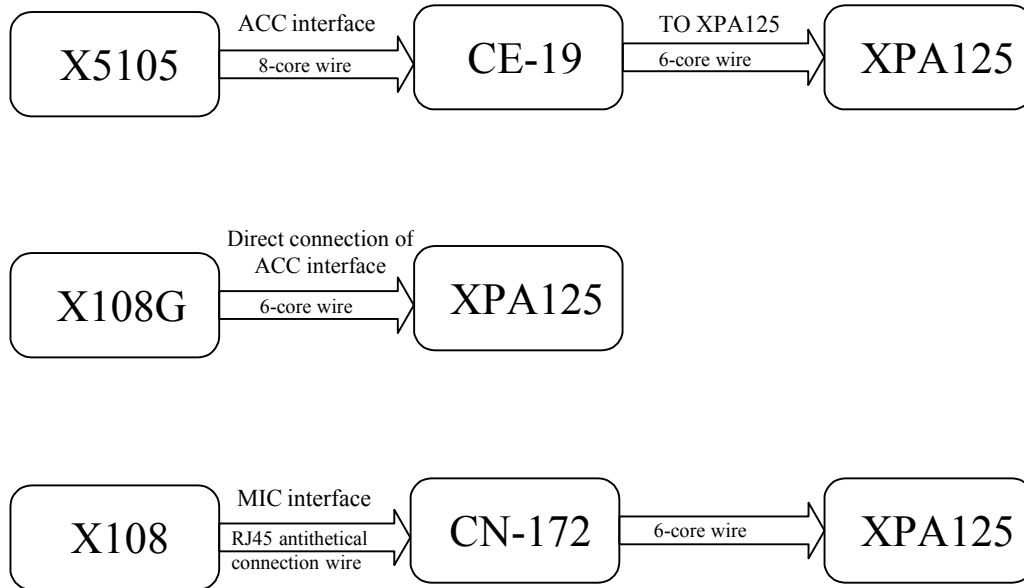

** Connection method of XPA125B is the same as that of XPA125.

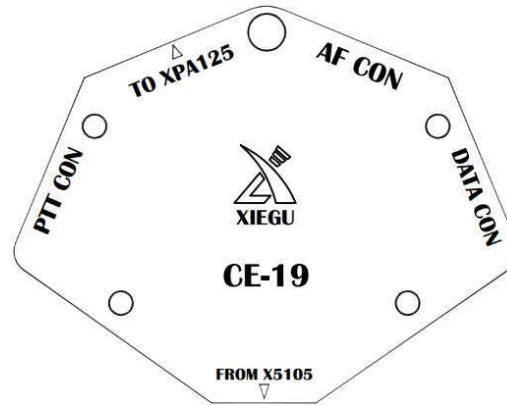
 Schematic diagram of CE-19 expansion card interface

PTT CON

PTT signal/BAND signal output port. PTT signal of the port is completely isolated from main machine, providing 'low level' trigger linked with main machine.

TO XPA125

Special interface for XPA125 power amplifier and antenna tuner AIO.

AF CON

Audio input/output port. Audio output from the port is directly output after demodulation without filter.

DATA CON

Data output port under NFM mode. Two terminals of the port are in parallel relationship, outputting same signals.

Copyright Statement

All Rights Reserved 2019

Chongqing Xiegu Technology Co., Ltd. reserves all rights of the manual. Any part of the manual shall not be copied without permission.

V3.0

1010160203-C