

# XIEGU

Portable SDR short wave transceiver

## G90S/G90

Operation manual

Built-in ATU

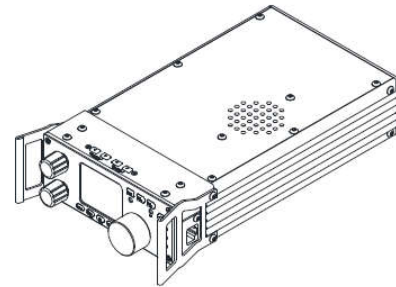

V1.0.4

## Contents

---

Basic characteristics	2	Call sign editor	29
Panel keys	3	Descriptions of system menu	30
Head interface	6	Data communication by connecting with computer	31
Tail plate interface	7	System parameter configuration	32
Interface definitions	8	Computer control instructions	32
Hand microphone key	9	Wave band voltage data	32
Connection of external power supplies	10	Performance parameter	33
Menu operation	12	Packed items	34
Display interface	12	Schematic diagram of connection between G90S and XPA125/125B Schematic diagram of CE-19	35
Transceiver start and shutdown	13	expansion card interface	36
Selection of working frequency range	14	Copyright statement	37
Selection of working mode	15		

## Contents

---

(MODE)	
Volume adjustment	16
Multi-function adjustment knob	17
Adjustment of transmitting power (Po)	18
Setting engineering frequency	19
Automatic antenna tuner (ATU)	20
Function key	21
SPL and VFO settings	23
CW communication	24
CW automatic pager	25
Standing-wave scanner SWR	25
Digital filer	26
Line input/output selection	27
Channel memory MW	28

## Panel keys

---

The G90S is a short-wave amateur radio transceiver with a portable 20W (built-in ATU) separable head in the SDR architecture. It is a new member of the Xiegu product family and the first portable SDR model in the G series.

Based on 24-bit-CODEC sampling, the G90S brings superior transceiver performance and a highly configurable feature experience; the separate head design allows you to flexibly position your host; with built-in high-performance ATU, you can meet your needs at any time. From then on, the antenna is no longer a problem.

- High performance front end narrow-band ESC preselector
- Covering the frequency range of 0.5~30MHz, SSB/CW/AM/ three working modes
- 1.8 inch high color TFT LCD
- $\pm 24\text{k}$  bandwidth spectrum display, waterfall display
- Software-defined narrow-band filter (CW mode can be as narrow as 50Hz), CW decoder
- Separable head design

## Panel keys

---

- Built-in standing-wave scanner
- Built-in efficient automatic antenna tuner

Please read this manual carefully for a better experience and full understanding on operation of the G90S.

■ G90S is a sales version in the People's Republic of China, and G90 is a sales version in other countries or regions. This manual applies to both models. The contents of this manual are explained with the G90S model.

## Panel keys

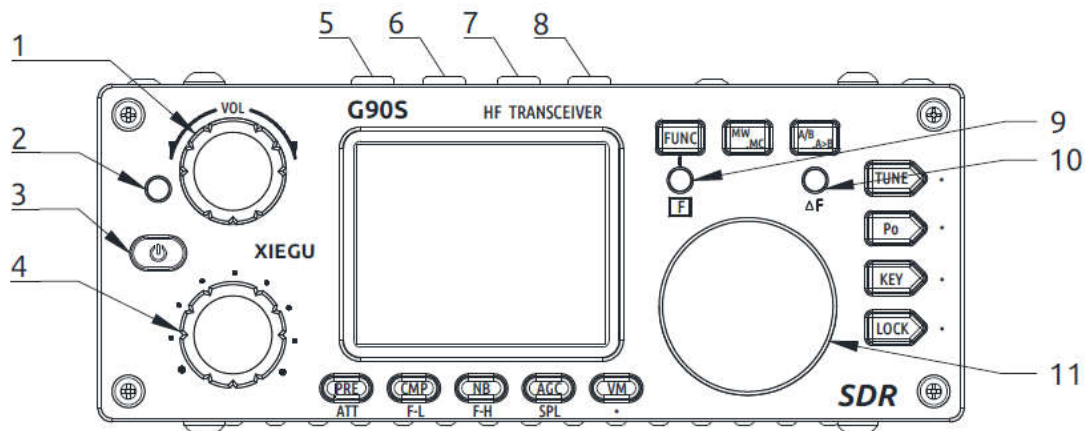

### **1 Volume knob**

- Turn the knob to increase or decrease the volume.
- Short press the knob to switch to the headphone output mode.

### **2 Power supply/transceiver indicator light**

- Standby/receiving state: yellow-green;
- Transmitting state: red

### **3 Power switch**

- In the power off state, short press this key to turn it on.
- In the power on state, long press this key to shut it down.

### **4 Multi-function adjustment knob**

- By default, turning this knob will step at 100kHz.

### **11 Main knob**

- Operate the knob to change the current frequency.

## Panel keys

---

- Long press this knob to switch to the Select Custom function.

### **5~6 MODE mode switching**

Mode switching.

### **7~8 BAND band switching**

Band switching.

### **9 FUNC indicator**

This indicator will be on when the second function of the key is operated.

### **10 ΔF indicator**

CW mode frequency alignment indicator.



## Panel keys

---

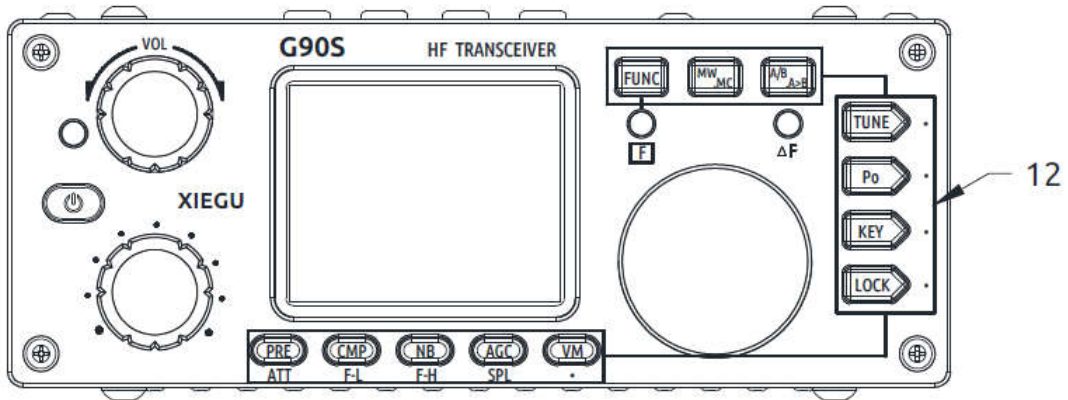

### 12 Function key

The key definitions and functions are detailed in the operation section.

## Head section interface

---

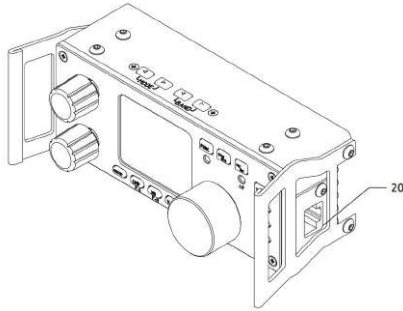

**20 MIC (microphone) interface (located on the right side)**

It is used to connect attached multi-function handheld microphone.

## Head section interface

---

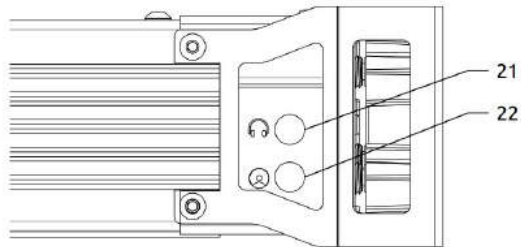

### **21 headphone interface (located on the left side)**

It is a 3.5mm stereo socket (3 wires) interface used to connect earphones.

### **22 custom (communication) interface (located on the left side)**

Used for firmware updates of the head (control 3S), or other functions.

## Tail plate interface

---

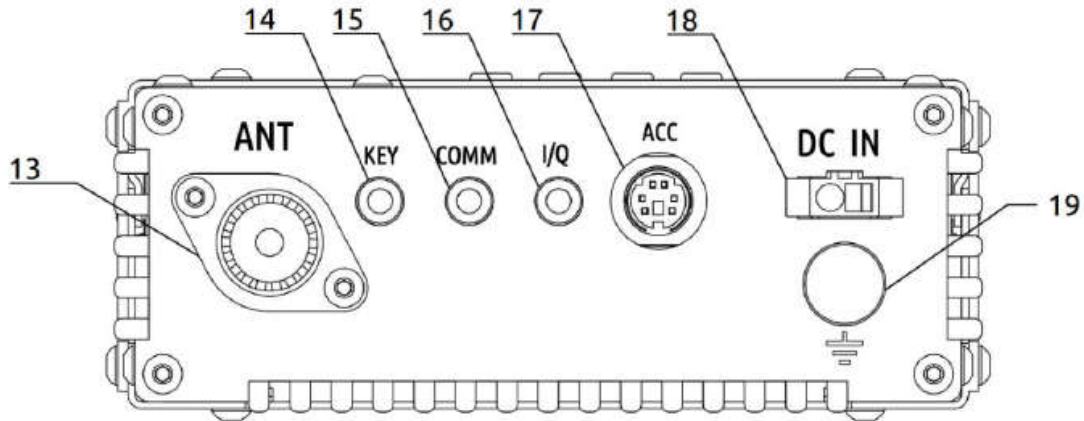

### **13 Antenna interface**

SL16-K type interface, impedance 50Ω.

### **14 KEY interface**

It is a 3.5mm stereo interface used to connect

### **15 COMM interface**

Used for host firmware updates.

### **16 I/Q signal output port**

3.5mm interface (3-wire) for IQ

## Tail plate interface

---

manual/auto telegram keys.

Wire connection of telegram keys are shown below:

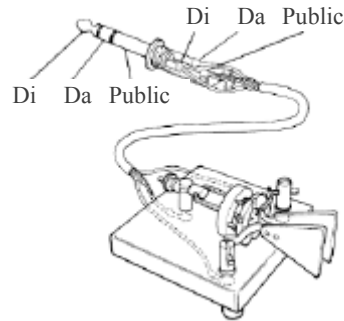

As for manual telegram key, 'di' and 'da' shall be connected together.

signal output.

### **17 ACC interface**

The interface is an 8-core mini-type DIN interface. See the interface definition for details.

### **18 DC power interface**

External DC power input interface. The round hole is the negative electrode and the square hole is the positive electrode.

### **19 Grounding terminal**

## Interface definitions

---

### 1. Microphone interface

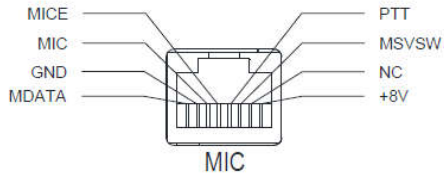

### 2. COMM connector



### 3. Headphone connector

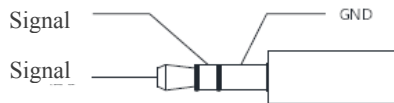

### 4. ACC interface

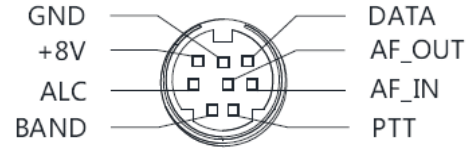

### 5. Wire connection of telegram keys

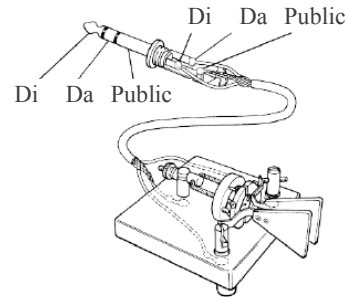

## Hand microphone key

- |                                |   |
|--------------------------------|---|
| 1. LOCK key                    | Lock key                                  |
| 2. PTT key                     | Transmitting control key                  |
| 3. Up/down                     | Frequency increase and decrease keys      |
| 4. Transceiver indicator light | Hand microphone operation indicator light |
| 5. Figure key area             | Figure keyboard area                      |
| 6. FIL key                     | Filter selection                          |
| 7. MODE key                    | Selection of working mode of main machine |
| 8. Functional indicator light  | <i>No</i>                                 |
| 9. Function keys               | F1/F2 custom settings key                 |
| 10. MW key                     | Storage                                   |
| 11. V/M key                    | Frequency/channel switching               |

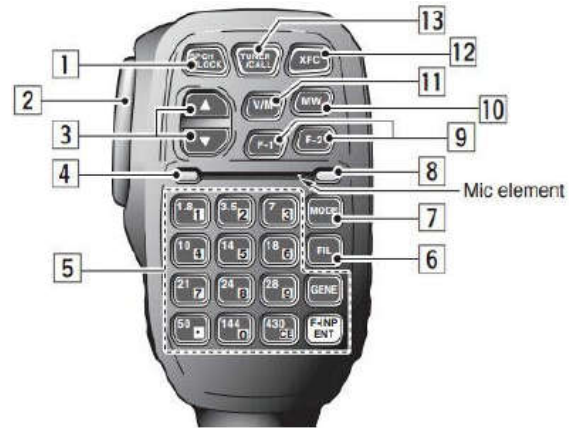

## Hand microphone key

---

- 12. XFC key    *No function*  
                  Press it in a long time to start
- 13. TUNER key antenna tuner for tuning



## Connection of external power supplies

---

13.8V external DC power supply is available for G90S. Current load capacity of DC power supply shall be 10A at least. Attached power lines can be used to connect to radio and DC power supply.

DC power supply shall be connected in strict accordance with following figure to avoid reverse polarity connection.

**Red line shall be connected with the positive pole of power supply and black line shall be connected with negative pole of power supply.**

## Connection of external power supplies

---

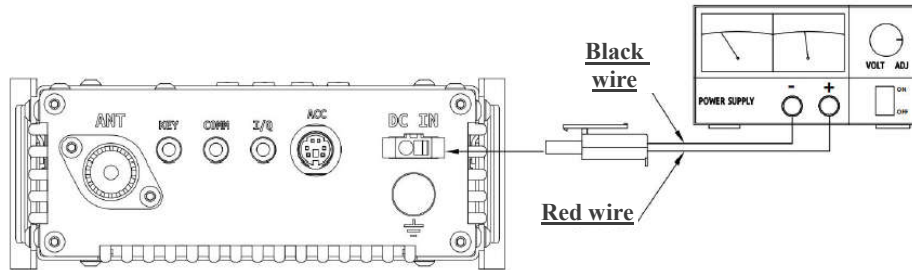

## Connection of external power supplies

---

EMC magnet ring can be applied on power lines to prevent external disturbance from entering radio via power lines and radio-frequency interference in radio from radiating externally via power lines when external power supply is adopted for G90S. Magnet ring shall be installed at the side closing to battery socket.

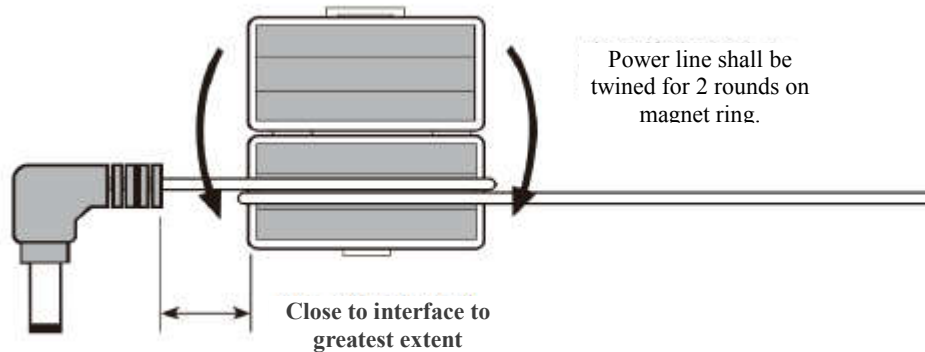

## Connection of external power supplies

---

- Polarity of power lines shall be carefully inspected to avoid reverse polarity connection when external power supply is adopted.
- Limited warranty of the radio does not include damages caused by wrong connection of external power supply or abnormal voltage.

## Operation

---

G90S adopts key-direct mode to enable or disable various functions. All functions are distributed on each function key (or in the second function).

If any function is turned on, off or adjusted, it will be displayed or reminded in the corresponding area on the screen.

The interface is displayed as follows:



## Operation

---



Dear User: In order to familiarize you with the functions and proficiency of the G90S portable transceiver as soon as possible, please read the operation guide of this manual to understand the powerful functions of the G90S. Let's go!

### Transceiver start and shutdown

1. Start the transceiver: short press



key.

2. Shut down the transceiver: press



and hold key for 1s under startup state.

Off screen operation:

Under startup state, short press the switch key to turn off the screen display.

At this point, the host is still in

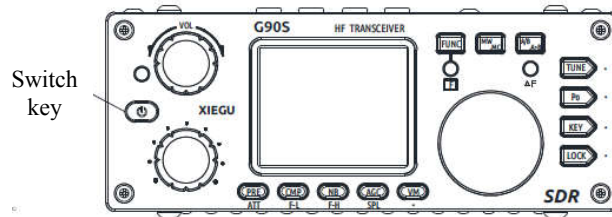

normal working condition. Pressing any key or turning the knob will turn up the screen display.



### Selection of working frequency range

Frequency range of G90S covers 0.5~30MHz. Amateur frequency in such range is divided into 10 frequency bands, and frequency band switch can be achieved by adopting many types of different modes.

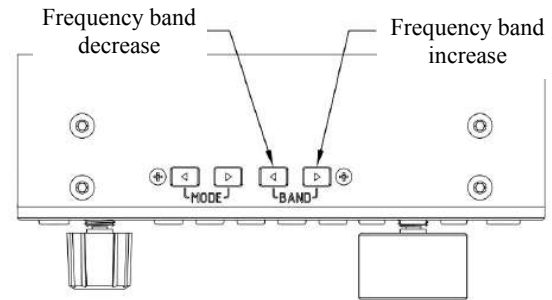

Operation methods:

Press < or > key on BAND to respectively switch to next or last operation frequency band.

## Operation

---

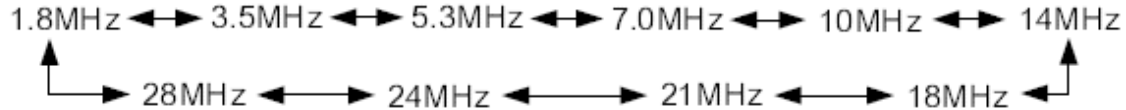

- Each amateur band has a user-defined frequency band that is convenient for temporary use. When the band is switched, the custom band passes.
- 60m frequency band shall be opened according to regulations of the country (or region).
- Frequency division for equipment in different versions is different, which shall be in accordance with the regulations of the country (or region).
- VFO-A and VFO-B are two independent VFO modes that can be set to different operating states. See [VFO Settings] for details.

## Operating mode selection

Press [MODE] key and switch the fixed sequence below among all modes

LSB -- USB -- CW -- CWR -- AM

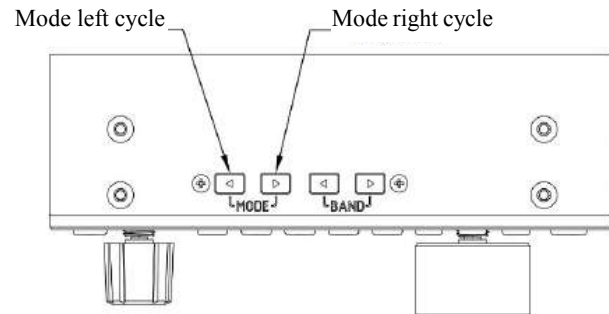

### Volume adjustment

#### Speaker mode:

Turn the volume knob to the left or right to adjust the output volume.

#### Headphone mode:

- Short press the volume knob to enter the headphone mode.
- Turn the volume knob to the left or right to adjust the headphone volume.

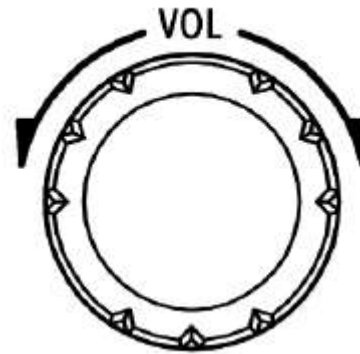

#### VOX mode on and off:

After pressing the [FUNC] key to activate the second function, short press the volume knob to

enter the VOX function setting option.

Descriptions of VOX menu:

VOX OFF/ON: VOX function off / on

VOX GAIN: Voice control gain setting

ANTI-VOX: Hand microphone and speaker echo suppression setting

VOX DLY: Voice-activated turn-off delay setting

- The voice control function can be enabled for both the hand microphone and the line input LINE.
- When using the AFIN port of the ACC interface for line input voice control, set the appropriate input volume level in the system menu.

### Multi-function adjustment knob

The multi-function knob provides multiple operating options and can be customized.

Operation methods:

Multi-function  
adjustment knob

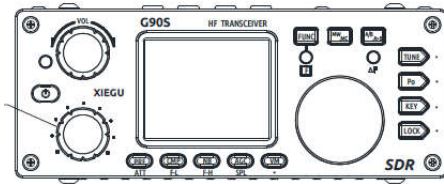

Default: Stepping of the 100 kHz frequency bit.

Short

press Enter SQL and adjust the SQL squelch depth.

Long

press: Enter the user custom function menu, rotate the main knob to select the corresponding function, and short press the SAVE key below the screen to confirm.

At this point, the function is projected onto the [Multi-Function Adjustment Knob].

## Operation

---

The customizable functions are as follows:

- |    |           |                                  |
|----|-----------|----------------------------------|
| 1) | Freq 100k | 100k stepping                    |
| 2) | SQL Level | Squelch setting                  |
| 3) | Po Level  | Transmission power setting       |
| 4) | Key Speed | Automatic key rate setting       |
| 5) | FFT Scale | Spectrum reference level setting |

### Adjustment of transmitting power

Operation methods:

1. Press [Po] key in a short time to enter power settings state, and the function display area on the right side of the screen will display the Po power setting value.

2. Rotate the [Multi-Function Adjustment Knob] to set the power, with the stepping of 1W.

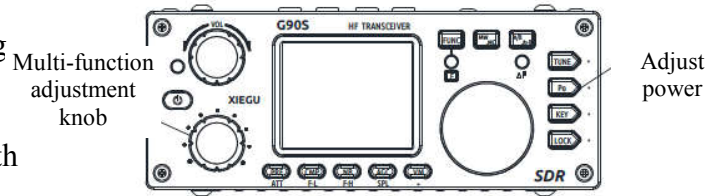

◆ Please minimize the preset transmitting power when using G90S transceiver for the first time under the condition of not understanding the current state of antenna.



### Working frequency settings

There are two methods for setting working frequency of G90S, i.e., set by using the main knob or multi-function hand microphone.

Operation methods:

1. Set frequency by using main knob

- Short press the main knob to select the 100Hz, 1kHz, 10kHz stepping bit;
- Rotate main knob and set the frequency of current step.

2. Set frequency by using multi-function hand microphone

- Press [F-INP ENT] key on hand microphone, and the G90S will be in frequency setting state, and cursor will be flickering at the first place on the left of frequency display position;

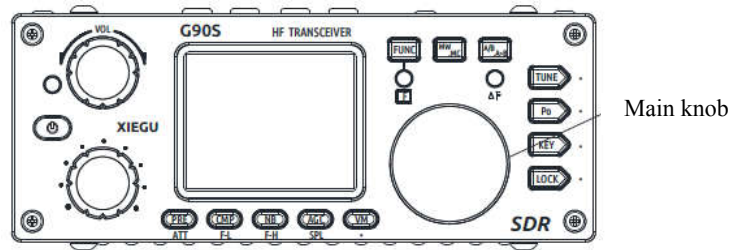

## Operation

---

- Respectively input expected frequency values, and press **[F-INP ENT]** key again to complete frequency settings.

For example, press keys in following sequence to set current frequency as 14.09000MHz:

1. Press **[F-INP ENT]** firstly;

2. Respectively press 

1	4	.	0	9	0	0	0
---	---	---	---	---	---	---	---

 key;

3. Press **[F-INP ENT]** again to complete the settings.

### ATU

There is an efficient ATU integrated inside the G90S transceiver to help you quickly erect and debug antenna.

- Press [TUNE] key in a short time to connect with built-in antenna tuner. There will be a "TUNE" icon at the top of screen.
- In the case of access to antenna tuning, press and hold the [TUNE] key for 1s to start ATU automatic tuning functions. IT will automatically return to receiving state after the tuning.

Notes:

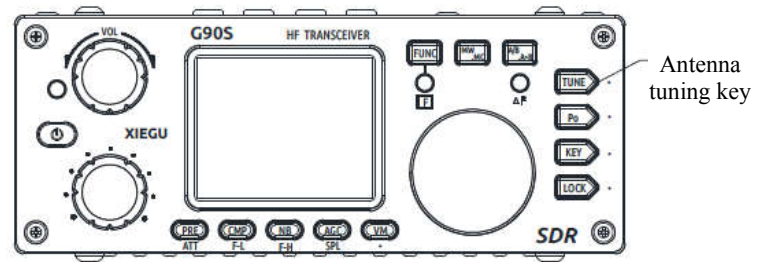

## Operation

---

1. Short press [TUNE] key, and there will be an antenna icon at the top of screen, indicating that antenna tuning functions are enabled. The functions are only enabled but not working.
2. Once built-in antenna tuning is adopted, tuning shall be carried out for one time after antenna tuning function is enabled.
3. If "SWR" icon is displayed at the top of the screen and flashes once transmitting is enabled after the tuning, it indicates that standing-wave of current antenna is still large and tuning is required to be carried out again.
4. Antenna tuning shall be turned off once natural resonance of antenna reaches current frequency band.
5. When using a whip antenna and starting the internal antenna tuning for tuning, strong radio frequency interference may be caused to the unit or electronic equipment.

### Function key

The common functions of the G90S are distributed on each function key.

**Some function keys have a second function. After selecting the function, turn the main knob to adjust the value.**

The operation of the second function:

- Press the [FUNC] key first, then the F indicator will be on, then press the corresponding function key.
- Press the [FUNC] key again to exit the second function. At this time, the F indicator is off.
  
- In any function (including FUNC second function), short press the main knob to exit the function setting and return to the main interface.

## Operation

---

### Function of the key

Key	First function (short press, cycle)	Second function (FUNC+)	Long press
PRE/ATT	PRE-ATT - straight-pass, cycle		/
CMP/F-L	Turn it on to transmit voice compression	Digital filter F-L, low-pass cutoff frequency selection	/
NB/F-H	NB SW - NB Level - NB Width, cycle	Digital filter F-H, high-pass startup frequency selection	/
AGC/SPL	Turn on the AGC function	Turn on the different frequency transceiver operation mode	/
VM.	Switch frequency mode or channel mode	<i>to be confirmed</i>	Start call number settings
MW/MC	Turn on channel memory function	Enter channel clear mode	/
A/B.A>B	Switch between VFO-A and VFO-B	Copy the current VFO to the background VFO	/
TUNE	Turn on/off the antenna tuning functions	/	Start antenna tuning
POW	POWER                      Transmission power	MIC GAIN                      Hand	Start

## Operation

---

	setting		microphone MIC gain setting	standing-wave scanning
	SWR THR Standing-wave protection threshold	INPUT	Voice input selection	/
KEY	SPEED Automatic key rate setting	CW volume	Side tone volume setting	CW decoding
	M/L/R Manual/automatic left and right mode switching	CW TONE	Side tone frequency setting	/
	MODE iambic A/B mode switching		/	/
	QSK Insert/non-insert selection		/	/
	QSK Time Insertion time settings		/	/
	Ratio Automatic key dot-and-dash interval proportion		/	/
LOCK	Level 5 screen backlight brightness setting	SCALE	Spectrum reference level setting	/





### Different frequency receiving and sending operation SPL and VFOA/B settings

G90S transceiver has two built-in independent VFOs which can respectively set different frequencies and modes. Cooperated with SPL function, it can conveniently achieve different frequency receiving and sending operations.

VFO settings:

1. Press[A/B / A>B] key in a short time to switch between VFO-A and VFO-B;
2. Set current VFO working frequency and mode when switching to a certain VFO state.

Different frequency receiving and sending SPL operation methods:

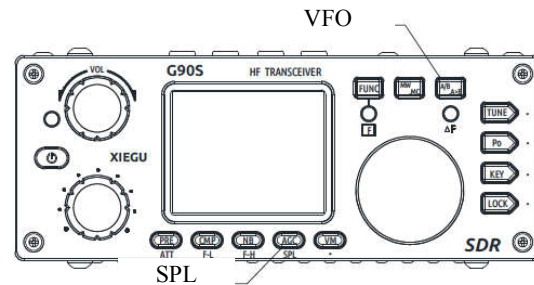

## Operation

---

1. Set receiving frequency and mode (VFO-A) firstly;
  2. Set transmitting frequency and mode (VFO-B);
  3. Operate the second function of the [AGC/SPL] key, turn on the SPL function, and turn on the different frequency transceiver mode.
- ◆ VFOA/B can be fully used to set different frequencies and modes, so as to achieve raid switching between two frequency points.

### CW communication

Use manual keys or external keying unit for operations.

Operation methods:

1. Insert keys (two-wire) in KEY interface;
2. Press [MODE] key to switch to CW (or CWR) mode;
3. Open the QSK function in the [KEY] key function and set the appropriate QSK time;
4. Press telegram key to enable CW communication.

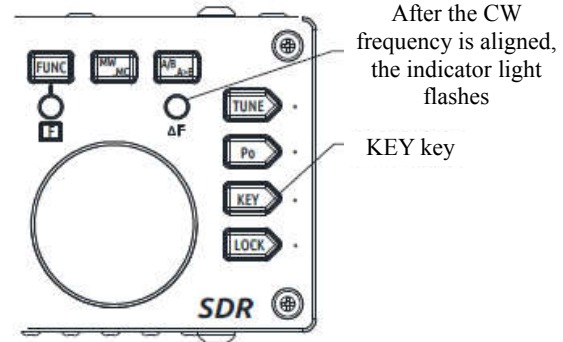

### Practice mode

You can take G90S as a CW code trainer in following methods:

Turn off the QSK function in the [KEY] key function. There will be CW sidetone of transceiver after pressing telegram keys under such conditions, but signals will not be transmitted externally.

### CW automatic decoding

Long press the [KEY] key to turn on the CW automatic decoding function and the decoded message information is displayed at the bottom of the screen.

◆ *The accuracy of CW automatic decoding is related to the reporting standard, signal propagation quality, and frequency accuracy of the other radio. Can be used as an auxiliary*

The [KEY] key function contains the adjustment items commonly used when doing CW communication:

- SPEED automatic key rate
- K-R/L Left / right hand habit
- Iambic A/B A/B mode
- QSK switch
- QSK time
- Ratio automatic key dot-and-dash interval

*decoding means with manual decoding.*

### **Standing-wave scanner SWR**

The G90S mainframe has an antenna standing-wave scanning function, which can scan the standing-wave parameters of the current antenna to facilitate the user to adjust the antenna.

Operation methods:

1. Long press the [POW] key to enable the standing-wave scanning function. Scan the standing wave of the antenna in the current frequency band.
2. Short press the key corresponding to BW displayed on the screen to switch the frequency stepping of scanning.
3. In the middle of the bottom of the screen, the frequency of the lowest point of the scanned standing wave is displayed.
4. Short press the key corresponding to FAST/SLOW displayed on the screen to select the scanning speed.
5. Short press the key corresponding to the QUIT displayed on the screen to exit the

standing-wave scanner.

Key correspondence:

BW: Corresponding to the [PRE] key

FAST: Corresponding to the [NB] key

QUIT: Corresponding to the [VN] key

◆ *Scanning results from the standing-wave scanner may have some error and are for temporary use only. For accurate measurement of antenna standing waves and other data, please use a professional antenna analysis device for measurement.*

### **Digital filer**

The G90S has a built-in variable digital filter that adjusts the bandwidth of the filter to improve signal identification.

Operation methods:

1. Short press the [FUNC] key to start the second function operation.
2. Press the [ CMP/F-L ] key and the [ NB/F-H ] key respectively to rotate the main knob to adjust the upper and lower boundaries of the filter to form filters of different bandwidths. Short press the [CMP/F-L] key and [NB/F-H] key again to display the currently set bandwidth value B in the function display area of the screen.



## Operation

- F-L: Adjust the low end cutoff frequency of the filter
- F-H: Adjust the high end cutoff frequency of the filter

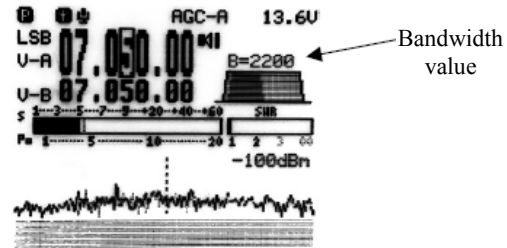

The parameters of the filter bandwidth are shown in the figure on the right:

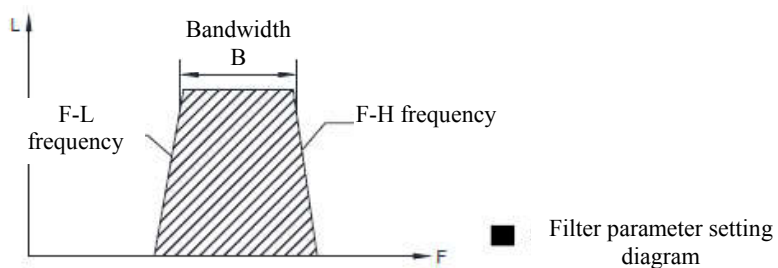

- ◆ *You can adjust the filter parameters according to your own usage habits to get the best experience.*

### Line input and output

The G90S has an external line input interface. When connecting with a computer or an external modem for data communication, the corresponding signal input option line input operation method shall be correctly selected:

- Input the external audio signal to the corresponding pin of the ACC port (see the interface description section for pin definition).
- Enter [FUNC +POW] second option: INPUT and select: LINE.
- In the system menu, select: AUX IN VOLUM to set the appropriate input volume.

Line output operation method:

- In the system menu, select: AUX OUT VOLUM to set the appropriate output volume.
- ◆ *When doing digital communication and using the ACC port for audio input, please ensure that the volume of the line input is  $\geq 200mV$  level.*

## Channel memory MW, clear MC

Channel memory:

1. In VFO mode, adjust the required frequency, mode, advanced function status and other parameters.
2. Short press the [MW/MC] key and the CH 00 (channel number) character will appear on the screen and flash. Rotate the main knob to select an empty channel. At this time, the character E will appear after the channel number, indicating that the channel is empty and can be used for memory.
3. Short press the [MW/MC] key again to save the current set frequency information to the selected channel.

Tune out the memory channel:

1. In VFO mode, short press the [VM] key on the panel to enter channel mode;
2. Rotate the main knob to switch the current channel.

Clear channel memory:

1. In channel mode, press the combination keys [FUNC] + [MW/MC], at which point the channel number starts to flash;
2. Rotate the main knob to adjust to the channel to be cleared. Press the [MW/MC] key again to clear the selected channel.

### **CALL SIGN EDITOR**

This unit can set the call sign information displayed on the startup interface.

Operation methods:

1. Long press the [VM] key to enter the text editor.
2. The bottom of the screen is the character selection area. Rotate the main knob to select the desired character. Short press the main knob to select the character.
3. Press the key corresponding to BACK to delete the last character; press the key corresponding to QUIT to exit the editor interface; press the key corresponding to SAVE to save and exit the editor interface.
4. At the startup next time, the edited text message will appear on the screen.

The correspondence between functions and keys:

SAVE: Corresponding to the [PRE] key



## Operation

---

BACK: Corresponding to the [NB] key

QUIT: Corresponding to the [VN] key



## Descriptions of system menu

Long press the [FUNC] key to enter the system menu.

The various menu functions are defined as follows:

S/N	Menu Name	Function description
1	Handle up/down	Hand microphone up/down key function setting
2	Handle F1	Hand microphone F1 key function setting
3	Handle F2	Hand microphone F2 key function setting
4	LCD BL	Screen backlight brightness setting
5	AUX IN Volum	ACC port input audio volume setting
6	AUX OUT Volum	ACC port output audio volume setting



## Operation

---

7	Version	Current firmware version number
---	---------	---------------------------------

Description of the multi-function key displayed at the bottom of the screen:

PREV: Previous page.

SAVE: After adjusting the system menu settings, press this key to save and exit.

EXIT: Exit the system menu interface directly.

NEXT: Next page.

### **Amateur radio data communications by connecting with computer**

G90S transceiver can be connected with computer and complete all kinds of data communications under the help of computer softwares.

Operation and connection methods:

1. Insert attached data cable into custom (communication) interface on the left side, connect G90S with computer, and ensure that drive of computer of data cable is correctly installed and PC software can control the G90S transceiver;
2. Connect the G90S's audio output signal (AF\_OUT pin of the ACC port) to the computer's audio input. The sixth item of the system menu can adjust the volume of the output signal.
3. Connect the computer's audio output signal to the G90S's audio input (AFJN pin of the ACC port). The fifth item of the system menu can adjust the volume of the input signal.
4. Set G90S to line input mode (see "Line Input, Output" setting).
5. Select corresponding working modes, i.e., carry out data communication.

## Operation

---

- ◆ Radio and computer must be well grounded to avoid interference, and EMC magnet ring shall be installed for data cable and audio cable at the position close to main machine of radio to greatest extent.
- ◆ The amplitude of the output signal of the radio and the amplitude of the output signal of the computer shall be appropriate to avoid overloading, and non-demodulation of the software on the computer side.

## Computer control instructions

G90S adopts standard CIV instruction sets. You can remotely control the transceiver based on standard instructions of the instruction set or configure control instructions of other softwares, so as to achieve the control on G90S.

## Wave band voltage data

ACC interface of G90S provides wave band data of each frequency band. The wave band data can control peripherals to achieve automatic wave band switch or can be used by other equipment to identify wave brand information.

Wave band	Voltage	Wave band	Voltage	Wave band	Voltage	Wave band	Voltage
1.8MHz	230mV	7MHz	920mV	18MHz	1610mV	28MHz	2300mV
3.5MHz	460mV	10MHz	1150mV	21MHz	1840mV	/	/
5.0MHz	690mV	14MHz	1380mV	24MHz	2070mV	/	/

## Performance parameter

---

### General parameters

Frequency range:

Receiving: 0.5MHz ~30MHz  
 Transmitting: 1.8 ~2.0MHz 3.5 ~3.9MHz  
 7.0 ~7.2MHz 10.1 ~10.15MHz  
 14.0~14.35MHz 18.068 ~18.168MHz  
 21.0~21.45MHz 24.89 ~24.99MHz  
 28.0~29.7MHz

Transmitting mode: A1A(CW),A3E(AM),J3E(USB/LSB)

Minimum step: 10Hz

Antenna impedance: 50Ω

Operating Temperature Range: 0°C ~+50°C

Frequency stability: ±1.5ppm @25°C within 10-60min after startup: 1ppm/h

Power voltage: 10.5~16.5V DC, negative electrode

### Receiver parameters

Circuit type: ZIF

Neighbor channel

suppression: ≥ 60dB

Sideband suppression: ≥ 60dB

Sensitivity:

	SSB/CW	AM
0.5 ~1.79999MHz	/	10uV
1.8 ~1.99999MHz	0.35uV	10uV
2.0 ~27.9999MHz	0.25uV	2uV
28.0 ~30.0MHz	0.25uV	2uV

(PRE=on, ATT=off, NB=off, NR=off, SSB/CW/AM = 10dB S/N, FM = 12dB SINAD)

Mirroring suppression: 70dB

Midband suppression: 60dB

Audio output: 0.5W (8Ω ≤ 10% THD)



## Performance parameter

---

Current consumption: grounding  
Receiving: 500mA@ Max,  
Transmission: 6A@ Max  
Size of the equipment: 120\*45\*210mm (W x H x L)  
(without protrusions)  
Weight: About 1.63kg (only main machine)

Transmitter parameters:  
Radio frequency output power: 20W (SSB/CW/FM)  
5W (AM carrier wave) @13.8VDC  
Modulation type: digital modulation  
Spurious emission suppression:  $\geq 50\text{dB}$   
Carrier suppression:  $\geq 40\text{dB}$   
Microphone impedance: 200~10k (600 $\Omega$  in general)

Audio output impedance: 4~16 $\Omega$

- ◆ Above specifications may be changed without notice.
- ◆ Working frequency range of transceiver varies from version of the equipment. Ask dealer for details.

## Packing List

---

### Standard Packing List

Item name	Qty.
G90S main machine	1 pcs
Multi-function hand microphone	1 pcs
USB data cable	1 pcs
DB9 extension cable	1 pcs
Separating head fixing stud	2 pcs
Hexagon wrench	1 pcs
Power supply cables	1 pcs
Operation manual	1 pcs
Warranty card	1 pcs
Quality certificate	1 pcs

### \*Optional accessories

Name of components	Description
CE-19	ACC expanded wiring card



## Packing List

---

XPA125B	100W power amplifier and antenna tuner AIO
GSOC*1	Large screen controller

\*1 The GSOC controller is expected to come into the market in 2019.



### Schematic Diagram of Connection between G90S/G90 and XPA125B



\*Note: The 8-core ACC wire is delivered in the CE19 kit, and the 6-core ACC wire is delivered in the XPA125B equipment box.

## Schematic diagram of CE-19 expansion card interface

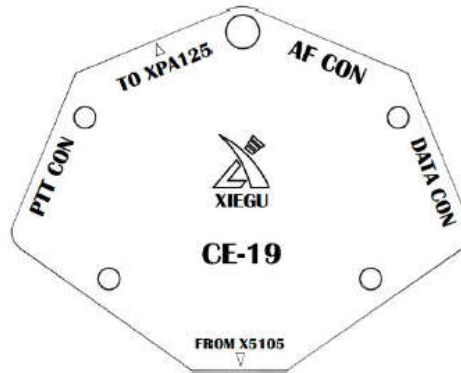

PTT CON

PTT signal/BAND signal output port. PTT signal of the port is completely isolated from main machine, providing 'low level' trigger linked with main machine.

## Annex 2

---

TO XPA125	Special interface for XPA125 power amplifier and antenna tuner AIO.
AF CON	Audio input/output port. Audio output from the port is directly output after demodulation without filter.
DATA CON	Data output port under NFM mode. Two terminals of the port is in parallel relationship, outputting same signals.

## Copyright statement

---

Copyright statement

All rights reserved 2018

Chongqing Xiegu Technology Co., Ltd. reserves all rights of the manual. Any part of the manual shall not be copied without permission.

---

1010160204-C

