

HF/50MHz Portable HF Transceiver

X5105

Instruction Manual

Chongqing Xiegu Technology Co.,Ltd.

V1.0.04-02

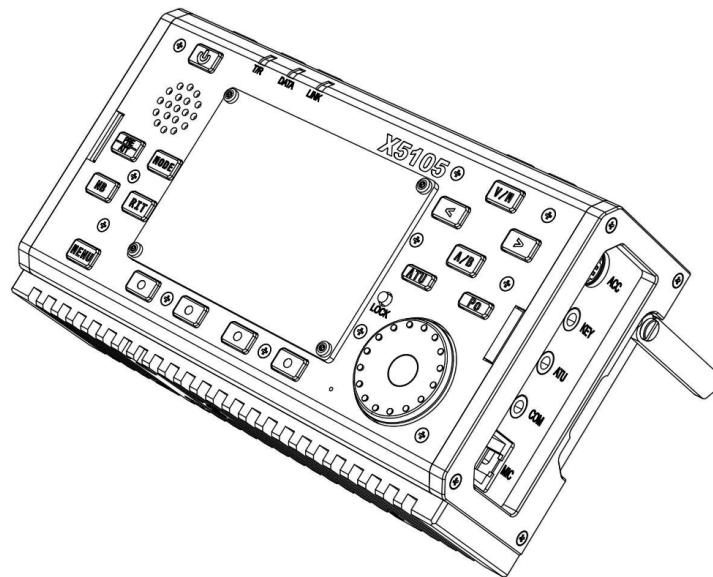

Catalogue

Introduction	2	Automatic gain control(AGC)	27	Parameter Configuration Chart	48
Panel Control & Switches	3	Pre-amplification/Front end Attenuator	28	Computer control Command	49
Left-side Jack	6	Noise Blanker(NB)	29	Band Voltage Data Chart	49
Right-Side Jack	7	Data Modem (MDN)	30	Specifications	50
Hand Microphone Functions	8	SPL & VFO Setting	31	Packing List	51
External Interface	9	VFO/MEMO mode Switching	32	XieGu Radio Products Connections With XPA125	
Internal Battery Charging & Maintenance	10	Locking Front Panel Controls/Turning The		Amplifier Chart	52
External Power Supply Interface	12	Poor Light On /Off	33	CE-19 expansion card interfacing	53
Menu Operation	14	CW transmission	34		
User menu	15	CW AUTO transmission	36		
LCD	16	Standing Wave Ratio Scanner(SWR)	37		
On/Off Transceiver	17	Digital Audio Filter (AFF)	38		
Battery level / voltage	18	Built-in or External MIC / line Input			
Operating Band Selection	19	Selection	39		
Operating Mode Selection	20	Speaker/Headset Mode Switching(SPK)	40		
Adjusting the Audio Volume Level	21	Memory Storage(MW)	41		
Adjusting Power output (Po)	22	Channel Tag (TAG)	42		
Built-in PTT button	23	Card Sign Number(CSN)	43		
Setting operating frequency	24	Data communication with computer	44		
Automatic antenna tuner (ATU)	25	Deploying System Parameter	45		
Receiver Incremental Tuning(RIT)	26	Reset	47		



Panel button

X5105 is a short-wave all-mode transceiver that is pretty interfaceable, which integrates all the functions required for shortwave amateur radio operation in a very limited volume, and realizes a interfaceable / mobile shortwave device in a real sense. Its powerful functions and performances make it easy for you to respond to various situations and receive signals from around the world.

- ✧ HF+50MHz all mode 5W output
- ✧ Extremely small size, about 168*93*47mm,interfaceable
- ✧ 3.6-inch large screen lattice LCD
- ✧ Built-in large-capacity lithium battery pack (3800mAh @ 12V)
- ✧ Built-in automatic antenna tuner
- ✧ Built-in digital baseband, can achieve many advanced functions:
 - Digital noise reduction NR
 - Digital NOTCH
 - Digital filter
 - Direct decoding of amateur radio data mode
 - With external adapters, data communication can be done directly without the need for a PC or a separate modem
 - CW automatic calling unit
- ✧ Built-in high stability TCXO
- ✧ **Manual button / automatic button mode switch**
- ✧ **Wide working voltage range**

For a better experience of this machine , read this manual carefully before use so as to fully understand the operation method of the X5105 .

Panel button

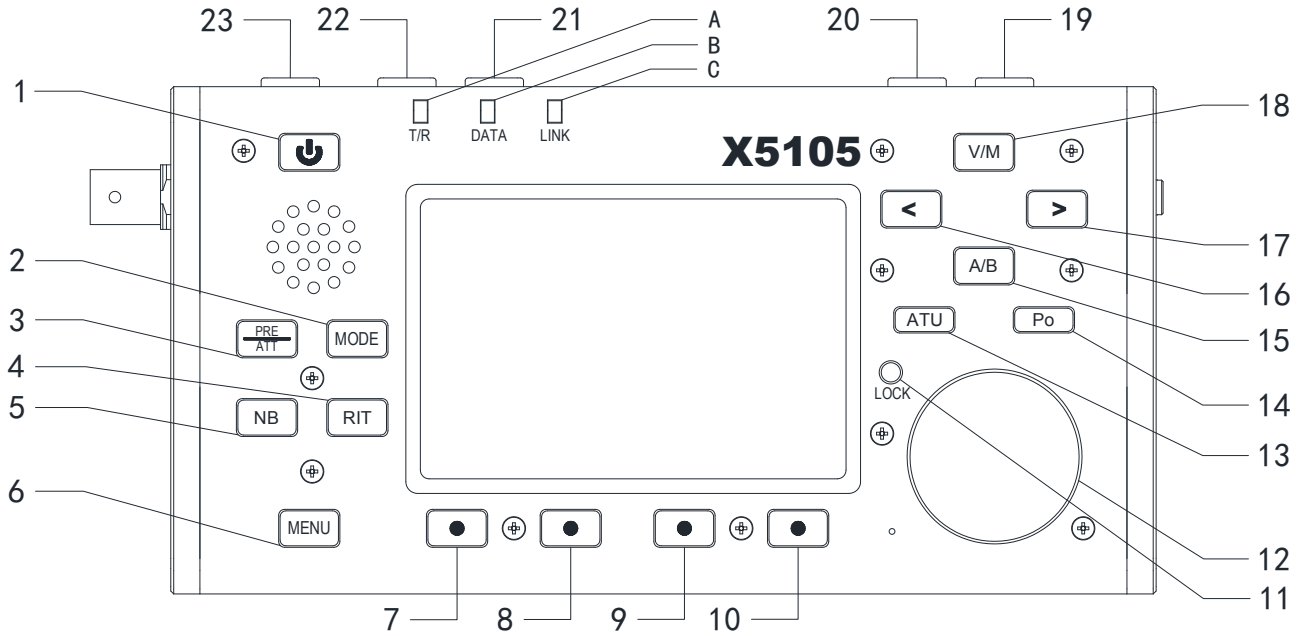

Panel button

- | | | | |
|---|--|--|--|
| 1 | Power switch
Press this button for one second to turn on or off the radio. | Short press this button will switch the multifunction menu currently displayed. | button to tune the automatic antenna tuner . |
| 2 | MODE button
short press this button changes the current mode of work and cycles in the following order:
[LSB-USB-CW-CWR-NFM-AM] | 7~10 Multifunction menu button
Short press these four buttons to turn on or off the corresponding functionality displayed in the menu area on the current screen. | 14 Po button
Short press this button, and with the main tuning knob, you can adjust the transmission power. The adjustment range is from 0.5 W to 0.5 W, and the stepping is to 0.5 W. |
| 3 | PRE/ATT button
Short press this button will turn on or off the preamplifier or attenuator in the following state:
[PRE=ON---ATT=ON---PRE/ATT=OFF] | 11 LOCK button
Short press this button will lock all button, knob action on the panel;
Long press this button for 1s, sets the screen backlight to turn off / on. | 15 A/B button
Short press this button, switching between VFOA / VFOB. |
| 4 | RIT button
Short press this button to turn on receive frequency trim function. | 12 Main knob
The main tuning knob of the station, it can be used not only for frequency regulation, but also for setting parameters. | 16 < button
Short press this button, the current frequency step moves one bit to the left. |
| 5 | NB button
Short press this button will turn NB function on or off. | 13 ATU button
Short press this button, the automatic antenna tuner will be connected to the antenna interface; Long press this | 17 > button
Short press this button, the current frequency step moves one bit to the left. |
| 6 | MENU button | | 18 V/M button
Short press this button will switch between VFO mode and MEMO mode. |

Panel button

Short press this button, will switch to higher frequency band.

20 DN button

Short press this button, will switch to lower frequency band.

21 Volume- button

Short press this button to reduce the current volume.

22 Volume+ button

Short press this button to increase the current volume .

23 PTT button

Press this button and the station will go into launch mode.

A T/R pilot lamp

In receiving state,It shows green

In setting state,It shows red

B DATA pilot lamp

The pilot lamp will flicker when data communication occurs.

C Link pilot lamp

When the host is connected to the peripheral, the indicator lights up.

Left interface

24 Antenna interface

BNC interface, impedance 50Ω.

25 Intermediate frequency signal outlet

The output receives the first intermediate frequency signal.

26 Left supinterface

Break out the bracket when use it. After using, retract the side guard.

27 Earphone interface

This interface is a 3.5mm stereo socket (3 wires) for connecting earphone devices.

**this interface function of different versions of the X5105 is different, be careful to distinguish.*

28 DC power interface

External DC power input interface, using the distribution of power wires to the external DC power supply to this interface. External DC power must be able to provide 13.8 V @ 3A power output. The interface is also used to charge the battery inside the machine.

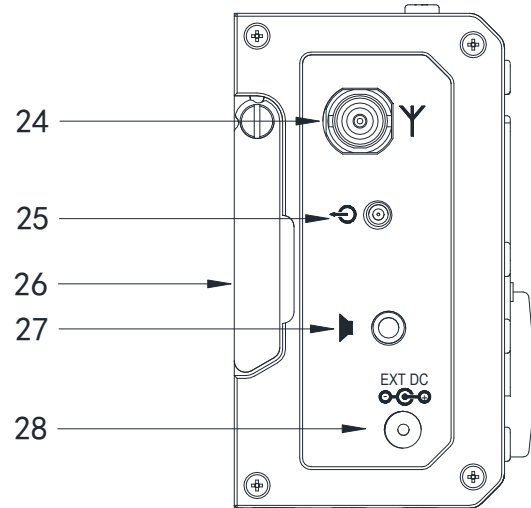

Right interface

29 ACC interface

The interface is an 8PIN miniature DIN interface, which can be used for external power amplifier connection control, PTT control, band signal transmission, and it can also be used to do data communication when the audio signal input / output.

30 button interface

The interface is a 3.5mm stereo interface for connecting manual / automatic Telegraph buttons.

The button connection is shown in the figure:

For manual button, "di" and "da" need to be connected together.

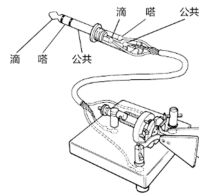

31 ATU interface

The interface is a 3.5mm interface (3-wire) for external day-tuning control.

**This interface function is not yet available.*

32 COM interface

The interface is a 3.5mm interface (3-wire) for computer-aided control system connections and firmware updates.

33 Right supinterface

Break out the bracket when used. After using, retract the side guard.

34 MIC (microphone) interface

Connect the configured multifunctional hand-held microphone to this interface.

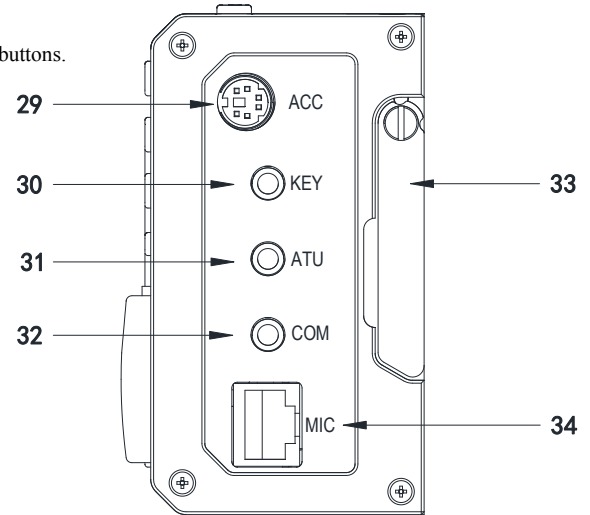

Hand-held microphone function

1、 LOCK button	Lock button
2、 PTT button	Launch control button
3、 Up / Down	Frequency increase, minus button
4、 Transceiver pilot lamp	Hand operation pilot lamp
5、 Digital button region	Digital buttonboard area
6、 FIL button	Filter selection
7、 MODE button	Host mode selection
8、 Functional pilot lamp	<i>Temporary no indication</i>
9、 Function button	F1/F2 custom setting button
10、 MW button	Store operation
11、 V/M button	Frequency / channel switching
12、 XFC button	<i>Temporary no function</i>
13、 TUNER button	Long press to start automatic sky modulation tuning in Machine

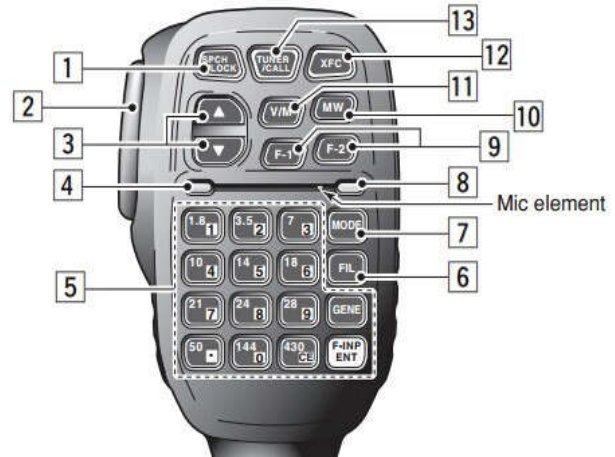

External interface description

1、 Microphone interface

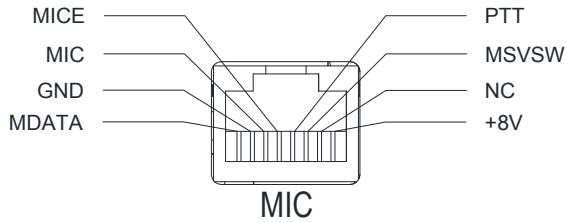

2、 CIV interface

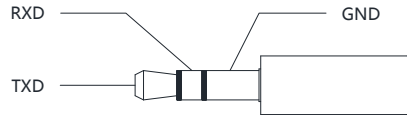

3、 Earphone interface

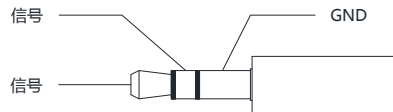

4、 ACC interface

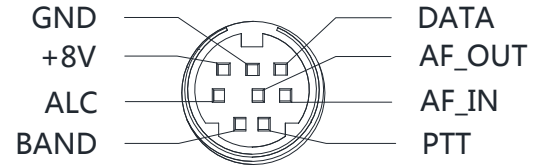

5、 button connection

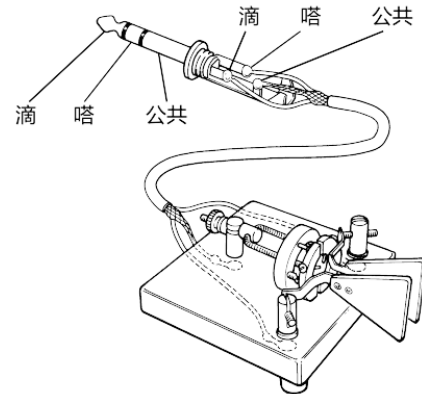

Note: 滴 (di) 嗒 (da) 公共 (public)

Charge and maintenance of battery in machine

X5105 has built-in 3800mAh polymer lithium battery pack. When the external power supply is not connected , a power supply is supplied to the whole machine by a battery pack ;When the external power supply is connected , the internal circuit of the machine is automatically switched to the external power supply .

Charging method:

- 1、 In the MENU -  【CHG】 option is the charging switch.
- 2、 Select "Charger ON" and open the charging function.
- 3、 Select "Charger off "and turn off charging.
- 4、 Set the external power supply voltage between 13.5V and 15.0V, connect to the X5105 external power supply interface, the host will start charging automatically.

Note: on shutdown, the X 5105 will automatically be

5、 The maximum charge time is about 10~12 hours. When the battery is fully charged, the charge will automatically stop, and the screen will show the end of the charge, as shown in the right picture.

After charging, the battery voltage is generally between 12. 1 V and 12. 5 V, which are all normal.

Charging...

Vext=13800mV

Vbat=11800mV

Screen display information in shutdown charging

Vext: Display external supply voltage

Vbat: Displays the current real - time voltage of the battery

Charge Finish

Vext=13800mV

Vbat=12200mV

Display information on screen after charging

Charge and maintenance of battery in machine

- In battery-powered mode, when the battery power is running out, the charge indicator in the upper-right corner of the screen is displayed as  , indicating that power should be charged or switched to an external power source immediately. During the charging process, the shell has a slight heating phenomenon.
- In normal use, the battery life is limited. When there is a significant drop in capacity or a charge failure, contact the dealer to replace it (The battery quality guarantee period is 3 months, It needs to be paid for replacement exceed the quality guarantee period) .



When using external power supply, do not exceed the rated voltage range of the equipment, otherwise it will cause damage to the equipment.



When abnormal heating occurs at the bottom of the housing near the battery, shut down immediately and place the equipment in a safe and ventilated place. Please contact us as soon as the safety condition is confirmed.

Connection of external power supply

The X5105 can use a 13.8V external DC power supply. The current load capacity of DC power supply is at least 3A. The randomly attached power cord can be used to connect the station to the DC power supply.

When connecting DC power, please carefully follow the logo below to avoid the power polarity reverse connection.

The white wire is connected with the positive pole of the power supply , and the metal shield wire is connected with the negative electrode of the power supply .

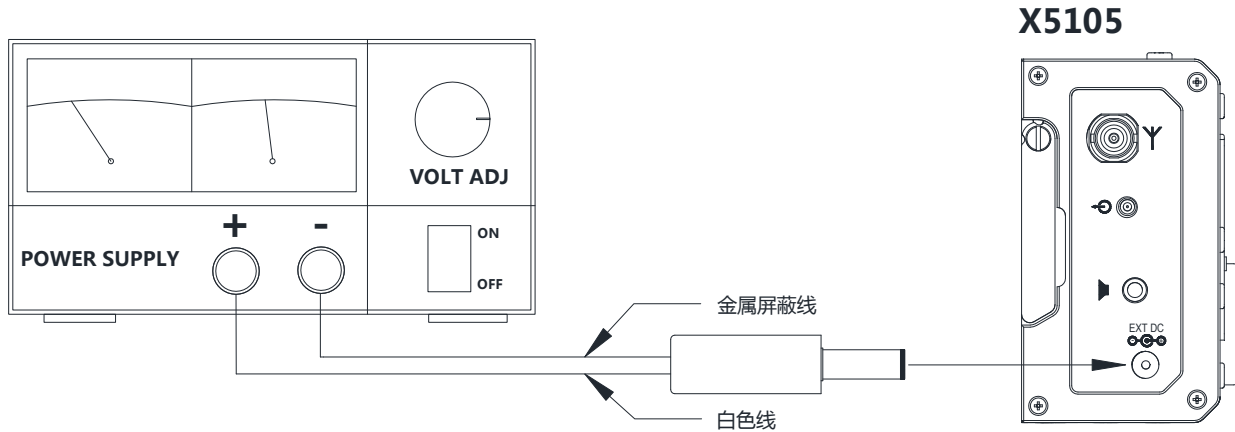

Note: 金属屏蔽线 (Metal shielded wire) ; 白色线 (White line)

Connection of external power supply

In order to prevent the external interference from entering the radio station through the power supply and the radio frequency interference radiating through the power wire, the EMC magnetic ring can be installed on the power supply wire when the X5105 uses the external power supply. The magnetic ring shall be installed as close as possible to the side of the power plug.

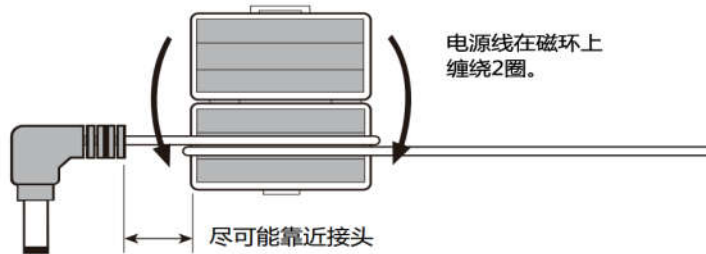

Note: 电源线在磁环上绕两圈（Wrap around two turns.）；尽可能靠近接头（As close as possible.）

- In the use of external power supply, please carefully check the polarity of power wires to avoid polarity back wiring.
- The limited warranty of this radio does not include damage caused by external power connection error or abnormal supply voltage.

Operation

A multi - function menu mode is used in X5105 to perform various functions for use or shutdown . All functions are distributed in 9 menu pages, with four options per page.

The menu is switched as follows:

- Short press MENU button, **the menu page number in the lower left corner of the screen starts flashing;**
- Rotate the large button to the desired menu page.

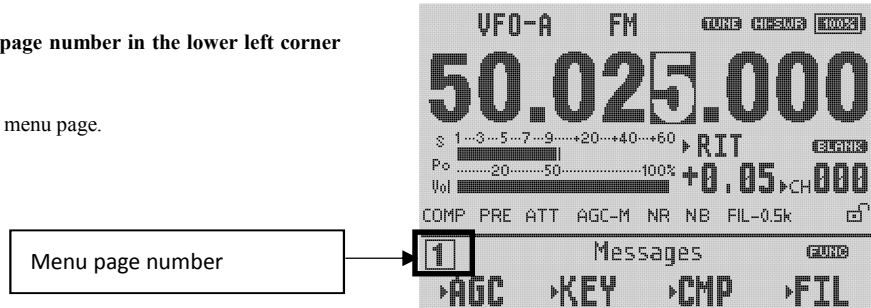

The four multifunctional buttons below the screen correspond to the displayed function menu.

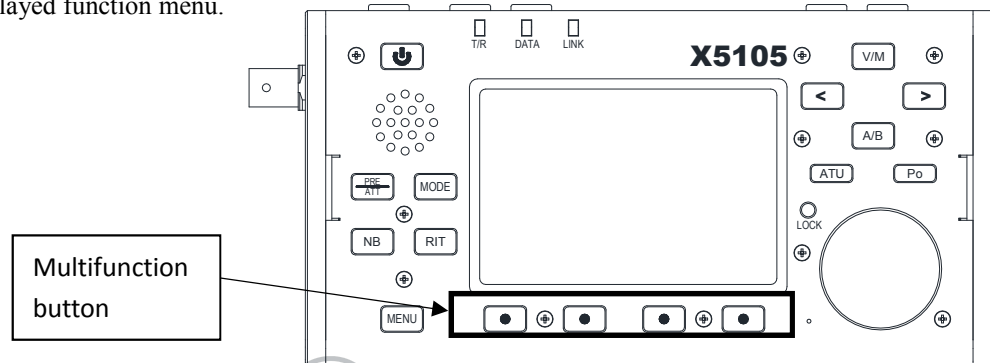

User menu

Menu page	Function			
1	Copy the current VFO to the background	Different frequency transceiver	Digital noise reduction	Digital NOTCH
2	AGC	Filter selection	Scanning receiving mode	Standing wave scanner
3	Write channel information to VFO	Store current settings	Clear current channel	Custom channel name Long press to enter editor
4	CW insert state	button manual / automatic mode switching	Automatic buttoning rate adjustment	/
5	Preset CW message 1	Preset CW message 2	Preset CW message 3	When starting up display call sign editor
	Long press to enter message editing	Long press to enter message editing	Long press to enter message editing	Long press to enter the editor
6	noise elimination	voice compression	Multifunction menu switching	Power / voltage display switch
7	charges switch	Internal, external MIC/ external audio input	IF output	Firmware version display
8	Digital MODEM	Carrier tracking (MDN=ON)	Frequency tracking (MDN=ON)	/
9	Digital audio filter	High-pass filter	Low pass filter	Speaker / headset mode selection

Operation

The X5105 uses a 3.6 inch black and white lattice LCD screen to display all the status information on the machine for easy observation. The visibility in the outdoor sun is also pretty good.

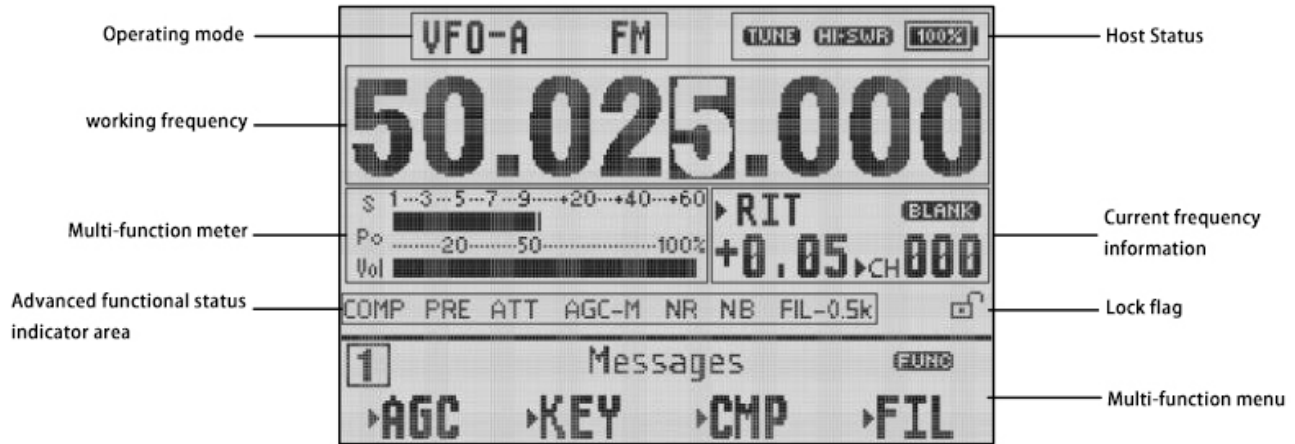

Operation

Dear users, hello. In order to make you become familiar with the functions of X5105 interfaceable transceiver as soon as possible and be proficient in the operation, please read the instructions of this manual carefully and understand the powerful function of X5105. Here we go!

Turn on / off the transceiver

1、 Turn on the transceiver: Press  button for one second.

2、 Turn off transceiver: When the machine is on,

Press  button for one second.

开关键

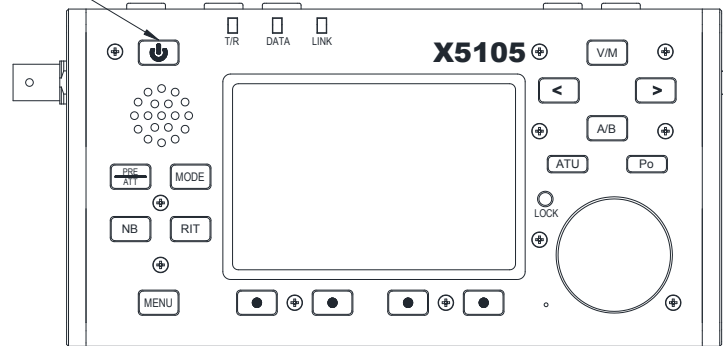

- ◆ *Hard reset: when the host system is in a dead state, such as button not responding, or unable to exit the launch state and button not responding, Long press switch button and hold for more than 8 seconds, reset MCU and force shutdown.*

Battery power / voltage display

- 1、 The upper-right corner of the LCD screen will show the current percentage of the battery remaining when using a built-in battery to power the transceiver.
- 2、 When using an external power supply, switch to page 6 of the menu and press [VLT] button, which displays the



- ◆ *If the X5105 transceiver is not used for more than 30 days, we recommend that you connect the external power to charge the device until the display is complete. See the operating instructions in the [charging] section for the specific operation steps.*

Operating Frequency Selection

The frequency range of X5105 covers 0.5~54MHz. The amateur frequency in this range is divided into multiple bands, which can



Operation method:

Press DN or UP button to switch to the next or previous operation band, respectively.

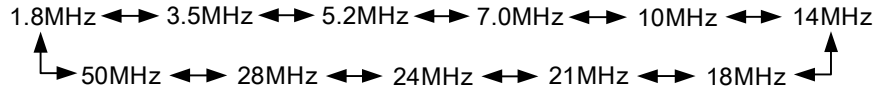

- The opening of the 5 MHz band depends on the laws and regulations of the country (or region) in which it is located.
- The frequency of different versions of the machine varies according to the laws and regulations of the country in which it is located.
- VFO-A and VFO-B are two independent VFO modes, which can be set to different working states respectively, see [VFO settings].

Operation

Work mode selection

Press [mode] button to switch between all modes in the following fixed order:

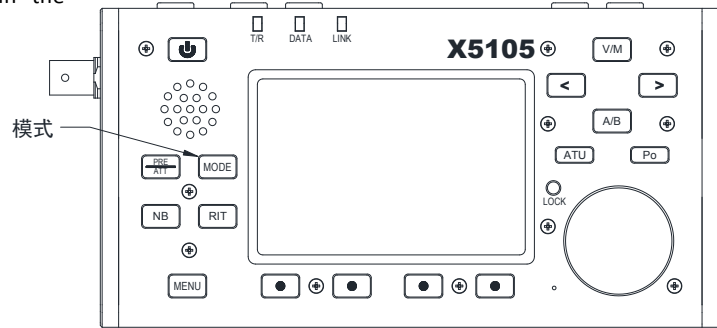
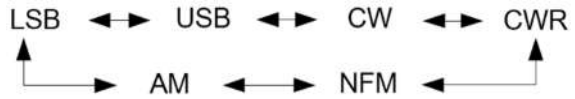

Volume Control

Press [volume +, -] button to adjust the output volume.

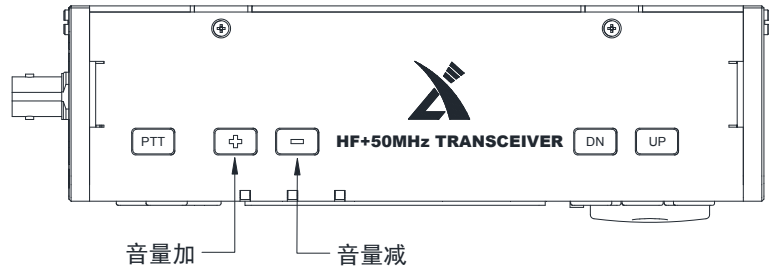

Note: 音量加 (volume +) , 音量减 (volume -)

When using the AF IN / OUT interface of ACC interface, please set the volume level in the system menu.

Regulate transmit power

Press [Po] transmit power settings button, you can set the transmit power.

Operation method:

- 1、 Short press[Po] button, enter the power setting state, and the screen will display Po power settings.
- 2、 Rotate the big knob and set the power, the stepping is 0.5 W.

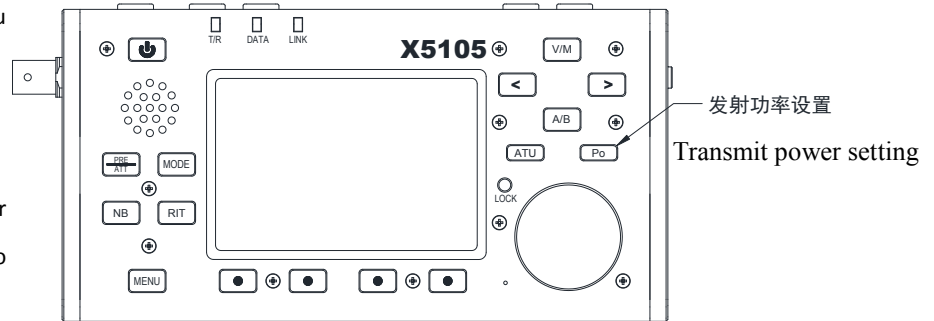

◆ When using the X5105 transceiver for the first time without knowing the current antenna state, please reduce the set transmit power value as far as possible.

Using native PTT button

The X 5105 is with a PTT button, which can be used to launch the transceiver.

Operation method:

- 1、 Press this button to start the transmitter launch function;
- 2、 Talk to the built-in MIC hole next to the knob and complete the connection.

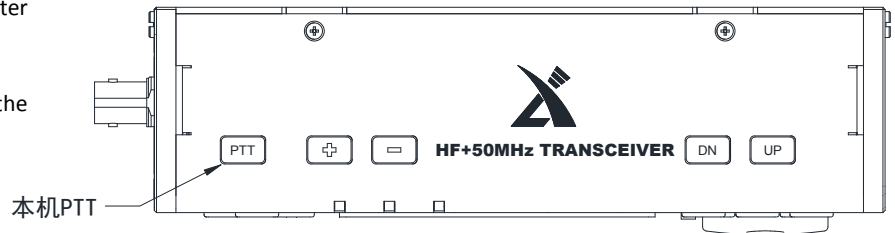

- You can try using the native **PTT button** and work with the built-in **MIC** (select **MSL** as **INT**) to make the device a handheld application.

Set working frequency

The X 5 105 sets the frequency in two ways, including a large knob to set the frequency, and a multi-function handheld frequency setting.

Operation method:

1、 Frequency setting with a large knob

- Press the cursor of button [$<$] and [$>$] to move the frequency bit left or right, and select the frequency bit of the desired stepping;
- Rotate the frequency knob to set the frequency of the current step carry.

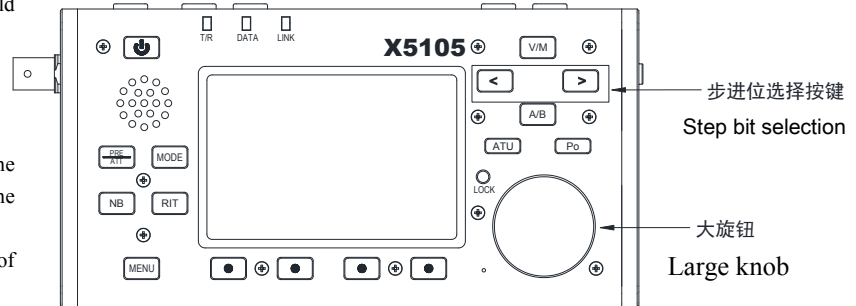

2、 Using multifunctional manual frequency setting

- Press [**F-INP ENT**] button, X5105 goes into the frequency setting state and the cursor flashes the first bit on the left of the frequency display bit;
- Enter the frequency value you want to set in turn, and press [**F-INP ENT**] button again to complete the frequency setting.

For example, set the current frequency to 51.50000MHz, press button in the following order:

1. First press the [**F-INP ENT**] button;
2. Press the numbering button in turn;
3. Press [**F-INP ENT**] button again to complete the setup.

Automatic antenna tuner

X5105 transceiver integrated a high efficiency automatic antenna tuner, which can help you easily complete the antenna erection and debugging work.

- Short press [ATU] button, will access the built - in antenna tuner above the screen and will display the " TUNE " sign above the screen .
- Long press [ATU] button for 1 second, automatic tuning of ATU will be activated. Upon completion of tuning, the received state is automatically returned.

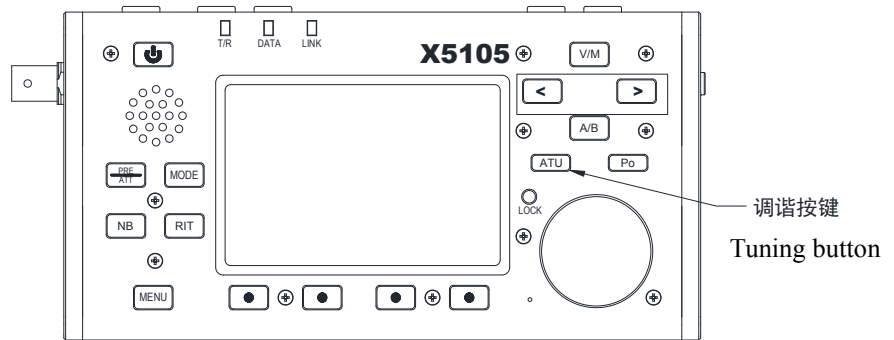

Note:

1. Short press [ATU] button, the " TUNE " character appears at the top of the screen, indicating that the diatonic function is turned on. It is only open, and the sky tune is not started.
2. In order to use the sky tone, it must be tuned once the sky tone function is opened.
3. After tuning, the "SWR" icon appears at the top of the screen and flashes, indicating that the standing wave of the current antenna is still large and needs to be tuned again.
4. When the antenna resonates naturally to the current frequency band, be sure to turn off the sky tune.

RIT reception frequency fine-tuning

The RIT function can set the offset of the actual receiving frequency from the maximum ± 1.5 kHz of the set frequency.

Operation method:

- 1、 Short press[RIT] button, start the RIT function;
- 2、 By rotating the knob, the frequency of the receiver can be changed in the range of ± 1.5 kHz. The corresponding area on the screen shows the change in frequency.
- 3、 If you want to clear the RIT offset value, long press[RIT] button for about 2 seconds, the value of the RIT setting is cleared after the prompt tone of “Di”.

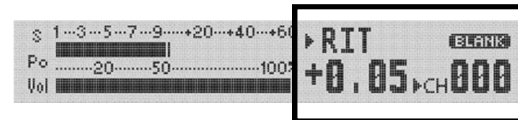
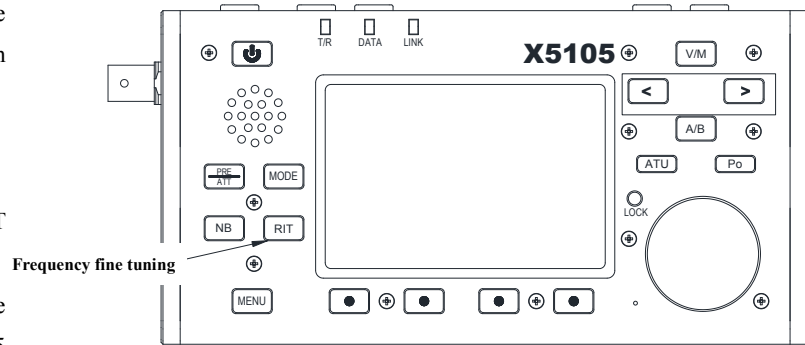

Automatic gain control AGC

By adjusting the AGC automatic gain control speed, the receiving effect can be optimized.

Operation method:

- 1、 Switch to the page 2 menu, short press[**AGC**] Functional button;
- 2、 The AGC function will be selected in the following order:

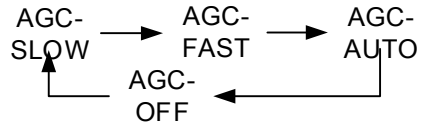

- 3、 When "AGC-AUTO" is selected, it is actually "AGC-FAST" in CW mode, and is "AGC-SLOW" in phonetic mode.
- ◆ If "AGC-OFF" is selected, the AGC system shuts down, the S table display will also stop.

Preamplifier / pre-attenuator PRE/ATT

Preamplifier (PRE) and pre-attenuator (ATT) can improve receiver listening performance. When the signal is weak, the preamplifier can be turned on to improve the signal intensity. When the signal is strong, the front attenuator can be turned on and the signal intensity can be reduced. You can also choose to turn off the circuit unit to get the signal through.

Operation method:

- 1、 Short press[PRE/ATT] button,this function can be activated.
- 2、 The switching order will follow the following cycle:

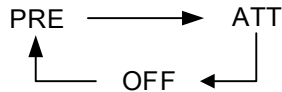

- ◆ The preamplifier can be turned off when the shortwave low frequency band (less than 10MHz) is in operation. At the moment, the signal direct access is more conducive to the improvement of the reception effect and avoid the obstruction of the receiver caused by the strong interference signal. In general, as long as the S table is observed to be changing, the preamplifier may not be turned on.

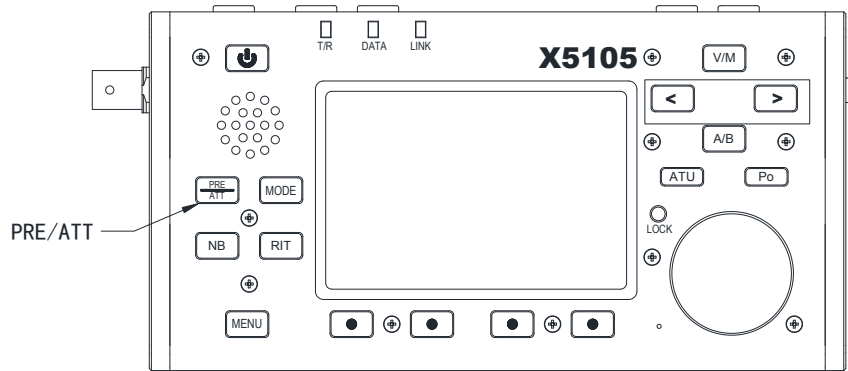

Noise Blanker NB

The noise blanker can effectively eliminate some specific impulsive interference, especially the noise generated by the automobile ignition system, and can improve the receiving effect significantly.

Operation method:

- 1、 Short press[**NB**] button, the corresponding prompt information appears on the screen, and the NB function is turned on.
- 2、 Once again short press [**NB**] button turns, will the NB noise blanker.

Noise suppression

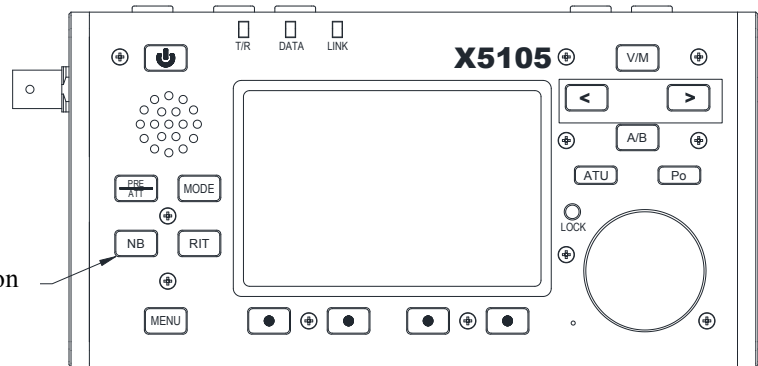

- ◆ NB function can only inhibit certain types of impulse noise, and can not replace NR noise reduction function.

Data modem MDN

X5105 has built-in amateur radio with commonly used data communication modem. You can use X5105 to demodulate data communication directly.

Operation method:

- 1、 Menu to the page 8, go to the data modem page, select [MDN], open the data function;[CAR]is carrier tracking mode;
- 2、 [AFC] is frequency tracking mode;

When the PSK31 * signal is received, the spectrum chart shows the spectrum of the corresponding signal, at the same time below will automatically demodulate the PSK31 mode modulation information.

- 3、 Press [MDN] button again to exit the data MODEM state;

* *Currently only PSK31 mode decoding is supported. Direct coding and demodulation of other modes will be supported through firmware updates and external input device interfaces*

Different frequency transceiver operation SPL and VFOA / B settings

There are two separate VFO inside the X5105 transceiver, which can set different frequencies and modes respectively. With SPL function, it can easily achieve the operation of different frequency transceiver.

VFO settings:

- 1、 Short press[A/B] button, can switch between VFO-A and VFO-B;
- 2、 When switching to a certain VFO state, you can set the current VFO operating frequency, mode and other settings.

Different frequency transceiver SPL operation method:

- 1、 Set the reception frequency and mode first (VFO-A) ;
- 2、 Then set up the launch frequency and mode. (VFO-B) ;
- 3、 Short press[MENU] button, switch to the first page menu, select the SPL function, and on the different frequency transceiver mode.

◆ It can make full use of VFOA / B to set different frequencies or modes, and to switch two frequency points quickly in real time.

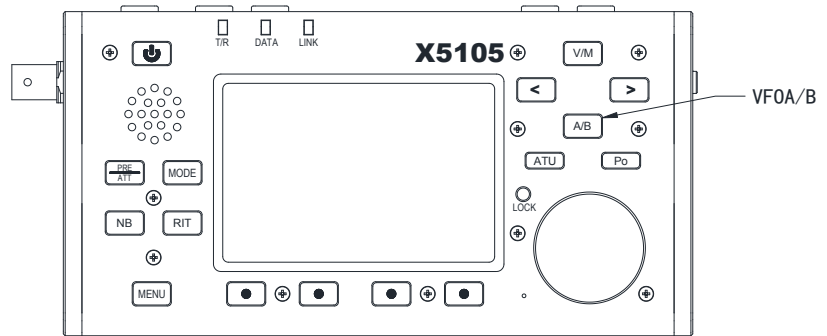

Operation

VFO mode / MEMO mode switch V/M

The transceiver can switch between VFO mode and MEMO mode, and the flexible operation mode is realized.

Operation method:

- 1、 Short press[V/M] button, You can switch between VFO (frequency) mode and MEMO (channel) mode.
- 2、 In the current mode, short press [V / M] button will switch to another mode state.

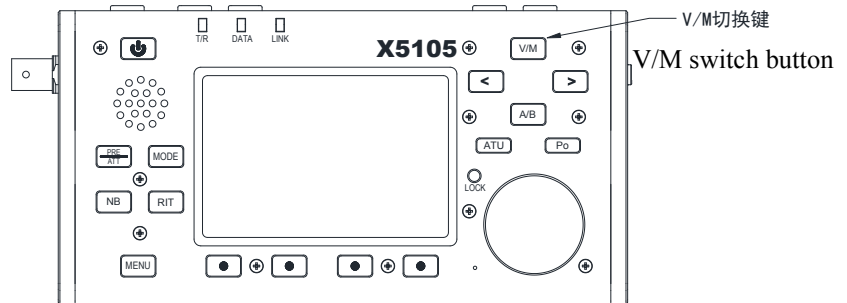

Operation

Button lock / backlight off LOCK

Lock button (LOCK) can avoid incorrect triggering of transceivers and handsets in outdoor operation. After the lock function is started, the other host panel button, knob and hand onamot button action are all invalid except PTT button and this button.

Operation method:

- 1、 Short press[**LOCK**] button to start lock;
- 2、 Again Short press[**LOCK**] button to release lock.
- 3、 After locking, the corresponding area on the screen will have a lock symbol display.
- 4、 Long press[**LOCK**] button, can completely turn off the screen backlight. Once again long press it, light will be turned on. This function is still in effect when the lock is turned on.

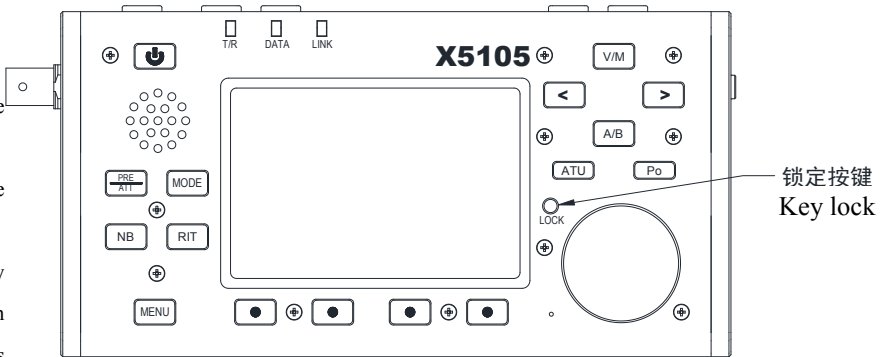

CW communications

Operate using a hand button or external buttoning device.

Operation method:

- 1、 Insert the button body (three-wire) plug into the button interface on the right side;
- 2、 Press [**MODE**]button, Switching mode to CW (or CWR);
- 3、 Long press[**MENU**] button, select the multifunctional button [<] and [>],turn out Menu #2 (CW T/Rx Delay Time),press the right entity button [<] and [>] and cooperate with the main knob, and set the delay time (Default: 500ms). Press the [**YES**] button at the bottom of the screen to save the new settings and exit the system menu mode;
- 4、 Short press[**MENU**] button, switch to the Page 4 menu and select the BK function .
- 5、 Press the button, you can carry out CW communication.

Practice mode

You can use X5105 as a CW code exerciser. Operation method is as follows:

Short press[**MENU**] button, switch to the Page 4 menu and select the BK function“OFF”.

In this state, when pressing the button, the transceiver has a CW side sound, but does not transmit a signal.

6、 The volume of the CW side sound can be adjusted through the system menu. The methods are as follows:

- ① Long press[**MENU**] button, enter system menu mode;

Operation

- ② Turn out system menu # 15 (BEEP Volume) ;
 - ③ Rotate the main knob, select the desired volume size, range from 1 to 7 is adjustable;
 - ④ When you are done, press the [YES] button at the bottom of the screen to save the new settings and exit menu mode.
- 7、 The tone of the CW side tone can be adjusted through the system menu # 3 (CW Rx Side Tone). The methods are as follows:
- ① Long press[MENU] button, enter system menu mode;
 - ② Turn out system menu # 3 (CW Rx Side Tone) ;
 - ③ Press the panel button [<] and [>] and rotate the master knob to select the desired tone, The range is adjustable from 50 Hz to 1200 Hz, with the default value of 800 Hz;
 - ④ When you are done, press the [YES] button at the bottom of the screen to save the new settings and exit menu mode.
- 8、 The choice of left and right hand Mode in CW Mode, can be adjusted through the system menu # 4 [**button**]. The methods are as follows:
- ① Short press[MENU] button, rotate the master knob to the page 4 of menu;
 - ② Press [**button**] button to select manual / left / right hand mode;
- 9、 The methods for adjusting the automatic buttoning rate are as follows:
- ① Short press[MENU] button, rotate the master knob to the page 4 of menu;
 - ② Press [**KSP**] button. rotate the main knob to adjust the automatic buttoning rate.

CW call maker RE1 ~ RE3

The X 5105 host computer provides three sets of CW preset message storage to realize the automatic call in CW mode.

Operation method:

- 1、 Short press[**MENU**] button, switch to page 5 in menu;
- 2、 Long press[**RE1**]~[**RE3**] function button for 2 seconds, enter the preset message editor;
- 3、 Under the text editor window, the tools used in text editing are provided at the bottom of the screen, press the corresponding function button can enable the corresponding function;
- 4、 After editing, press [**save**] button, save the edited message and return to normal operation;
- 5、 Short press[**RE1**]~[**RE3**] function button, the CW automatic call can be started.

Standing wave scanner SWR

The X 5105 host has the function of antenna standing wave scanning, which can scan the standing wave parameters of the current antenna and facilitate the user to adjust the antenna.

Operation method:

- 1、 Short press[**MENU**] button, rotate the main knob to page 2 in menu;
- 2、 Press [**SWR**] button to activate the standing wave scanning function;
- 3、 Under the scanner interface, the standing wave of the current antenna can be observed intuitively;
- 4、 Press [**BW**] function button, you can set the standing wave scanning bandwidth;
- 5、 Press[**QUIT**] button to exit the standing wave scanner;

◆ *There may be some errors in the scanning results of the standing wave scanner. If you need to accurately measure the antenna standing wave and other data, please use a professional antenna analysis equipment to measure.*

Digital filter AFF

This machine has built-in digital audio filter, which can realize narrow band filter function and enhance signal identification.

Operation method:

- 1、 Short press[MENU] button, rotate the main knob and switch to the page 9 in menu;
 - 2、 Select [AFF] to turn on the digital filter function. At this point, the [HPF] and [LPF] functionality options are displayed;
 - 3、 [HPF] is a high-pass filter option, and [LPF] is a low-pass filter option. Select any filter and rotate the main knob to adjust the filter parameters. The two groups of filters can be collocated to form an ultra-narrow band filter, which can significantly improve the hearing sensitivity and identification degree of the signal.
 - 4、 Press [AFF] function button again to turn off the digital filter function.
 - 5、 When you open the digital filter, the firmware default setting parameters are as follows:
SSB mode: HPF is 300Hz, LPF is 2200Hz.
CW mode: HPF is 500Hz, LPF is 900Hz.
- ◆ You can adjust the filter parameters according to your listening preferences to get the best sense of hearing.

Built-in and External MIC/ wire input selection

X5105 has 3 audio input channels, which are built-in MIC、 external MIC、 ACC interface's AF_IN wire input. When using, select the appropriate input item correctly.

Operation method:

In the user menu Menu-7, the **【MSL】** option is a built-in and external MIC / wires option. Short press this item to switch.

- When use external MIC, select: EXT MIC
- When use built-in MIC: select: INT MIC
- When use ACC interface wire input, select: AUX wire IN

◆ Note: when doing digital communication and using the ACC interface for audio input, select AUX wire IN. And make sure the wire's volume is high enough.

Loudspeaker / headphone mode switching SPK

X5105 can select speaker / headset mode for audio output in different use environments.

Operation method:

- 1、 Short press[MENU] button, rotate the main knob to the page 9 in menu;
- 2、 Select [SPK] to switch between loudspeaker / headphone modes. At this point, the left side of the screen will display the corresponding horn icon or headphone icon, used to distinguish the two modes;

◆ *In loudspeaker mode, do not insert headphones directly to avoid damaging your hearing and earphone devices.*

Channel storage MW

Channel storage:

1. In VFO mode, adjust the required frequency, mode, advanced functional state and other parameters;
2. Short press[**MENU**] button, rotate the master knob to the page 3 in menu, select [**MW**] function to start channel storage operation;
3. Rotate the master knob to select the channel number that needs to be stored, short press[**YES**] button, the channel storage can be completed;
4. If the current channel has stored information, and then use this channel number to store, the channel information will be cleared and the current channel information will be saved.

Turn out storage channel:

- 1、 If in VFO mode, short press [**V/M**] button on the panel, it will enter the channel mode;
- 2、 Rotate the encoder to switch the current channel.

Clear channel storage:

- 1、 In channel mode, press the [**MC**] function button to activate the channel clearance function;
- 2、 At this point, the channel number starts flashing. Rotate the main knob to the corresponding channel number, short press[**YES**] button, then the channel clearance can be completed.

Channel naming TAG

The stored channel can be named after a “label” consisting of letters and numbers.

Operation method:

- 1、 Turn out the channel you want to name;
- 2、 Short press[**MENU**]button, rotate the main knob to the page 3 in menu, Long press [**TAG**] button for 2 seconds to release, and enter the text editor;
- 3、 In the text editor, the tools used in text editing are provided at the bottom of the screen, press the corresponding function button can enable the corresponding function;
- 4、 After editing, press[**SAVE**]button, save the text content and return to normal operation state;
- 5、 In channel mode, short press[**TAG**] button, you can switch between channel numbers / custom channel names.

Call sign setting for boot interface CSN

This machine can set up the call sign information displayed on the boot interface.

Operation method:

- 1、 Short press[**MENU**] button, rotate the main knob to page 5 in menu, select [**CSN**] function, enter call sign editor;
- 2、 In the editor, the tools used in text editing are provided at the bottom of the screen, press the corresponding function button can enable the corresponding function;
- 3、 After editing, press [**SAVE**] button, save the text content and return to normal operation state;
- 4、 When you boot again, the boot interface will display the text information you edit.

Amateur radio data communication with computer connections

X5105 transceiver can connect with computer and complete all kinds of data communication with corresponding computer software.

Operation wire method:

- 1、 From the ACC interface (MINI-DIN8), the computer audio output / input is connected to X5105.
- 2、 Insert the data wire of the distribution into com (or CIV) interface, and connect the X5105 to the computer, and ensure that the data wire computer driven and installed correctly with PC software can control the X5105 transceiver;
- 3、 Adjust the volume of the X5105 ACC interface input / output volume to the appropriate, observe the software interface to avoid too much audio to communicate.
- 4、 Select the corresponding working mode, you can carry out data communication.

- ◆ *To prevent interference , the station and computer must be grounded well , and the data cables and audio wires should be fitted with EMC magnetic rings and installed as close as possible to the end of the station .*

System parameter configuration

System parameter configuration

System settings menu can be personalized transceiver settings to make it more in wire with your use habits.

Operation method:

- 1、 Long press [menu] button for 1 second, enter the system settings menu;
- 2、 Press the [<] and[>] multi-function button below to screen, turn out the menu items you want to set.
- 3、 Press [<] and [>] button on the panel and rotate the encoder to set the parameters you want;
- 4、 When the setup is complete, short press[YES] button, save the current settings and exit menu mode.

◆ In step 4 above, if Short press [NO] button, the new settings will not be saved and the system menu mode will be exited.

System menu description

Menu item	Function declaration	Configurable value	Default	
01	RF GAIN	Receiving RF gain	0~100%	65%
02	CW T/Rx Delay Time	CW emission delay	0~5000ms	200ms
03	CW Rx Side Tone	CW receiving side tone	50~1200Hz	800Hz
04	Tx AF Gain SSB	MIC gain in SSB Mode	0~100%	
05	Tx AF Gain AM	MIC gain in AM Mode	0~100%	50%
06	Tx AF Gain NFM	MIC gain in NFM Mode	0~100%	100%



Operation

07	RX AF Gain SSB	SSB mode receiving audio gain	10~100%	40%
08	RX AF Gain AM	AM mode receiving audio gain	10~100%	90%
09	RX AF Gain NFM	NFM mode receiving audio gain	10~100%	90%
10	LCD Backlight Level	Screen back brightness adjustment	0~100%	80%
11	Ref Clock	System reference clock	26000000Hz	Don't change!
12	NFM TX IF	NFM mode transmit intermediate frequency	10697000Hz	Don't change!
13	Misc Option	Digital baseband configuration	0x7A5C3360 / 0x59A03360	
14	Beep Volum	System volume	1~7	4
15	AUX AFIN Volum	External input audio volume of ACC interface	0~7	7
16	AUX AFOUT Volum	ACC interface output volume	0~31	3
17	User Key F1	Hand onamot F1 button Custom	/	TS-
18	User Key F2	Hand onamot F2 button Custom	/	TS-
19	Ext MIC Bias	External MIC bias setting	Disable / Enable	Enable
20	CTCSS Tone	Launch sub tone setting		69.3Hz
21	CTCSS(Tx only)	Transmit sub tone switch	Disable / Enable	Enable
22	Reset ALL	Reset all system parameters	No / YES	No

- ◆ *The default parameters ensure that the transceiver works in a better state. You can also fine-tune the above parameter settings according to your own use habits.*

Restoration of factory setting

When the system parameter setting error causes the host to be unable to work, the reset operation can be used to reset the transceiver. At that time, all system parameters on the transceiver will be restored to the factory default data.

Operation method:

Enter the system menu, select item 22 **【Reset ALL】** menu, rotate the main knob to set it to "YES" and press [YES] button below the screen.

- ◆ After reset, all system parameters will revert to the factory default status.
- ◆ According to the serial number of your device, combined with the [configuration parameter list], the system menu part of the project will be reconfigured and saved.
- ◆ When all settings are complete, press [YES] button to save.

Configuration parameter list

After updating the firmware, be sure to configure X5105 as described in this document, otherwise the device will not work properly!

- After the firmware is updated, go directly to item 21 of the system menu **【Reset ALL】** and reset the system parameters.
- After the reset is complete, consult the appropriate configuration parameters in accordance with the serial number of the serial number of the host.

Configuration one:

Application range: X0300001~X0300150 / 0300001~0300220

Menu Item		Function Description	Recommended setting
4	Tx AF Gain SSB	MIC gain in SSB mode	60%
14	Misc Option	Digital baseband configuration	0x7A5C3360
20	Ext MIC Bias	External MIC offset setting	Enable

Configuration two:

Application range: X0300151 and its follow-up / 0300221 and its follow-up

Menu Item		Function Description	Recommended setting
4	Tx AF Gain SSB	MIC gain in SSB mode	80%
14	Misc Option	Digital baseband configuration	0x59A03360
20	Ext MIC Bias	External MIC offset setting	Enable

1. After setting up, click **SAVE** to save, exit system menu. Execute a boot and shutdown immediately.
2. When you first use it, check if the **SQL**、**NR**、**NTH** project is set up. If the settings are in place, please clear them all manually. And press all button.
3. When using a preset message for the first time, please manually delete all scrambled symbols in **RE1~RE3**.

System parameter configuration

Computer control instruction

A standard CIV instruction set is used to enable you to remotely control the transceiver with the standard instructions of this instruction set , the control instruction part of other software can also be configured to realize the control of X5105.

Band voltage data

The ACC interface of X5105 provides band data for each frequency band. The band data can control the peripheral equipment to switch band automatically or give other equipment to identify band information.

Wave Band	Voltage	Wave Band	Voltage	Wave Band	Voltage	Wave Band	Voltage
1.8MHz	230mV	7MHz	920mV	18MHz	1610mV	28MHz	2300mV
3.5MHz	460mV	10MHz	1150mV	21MHz	1840mV	50MHz	2530mV
5.0MHz	690mV	14MHz	1380mV	24MHz	2070mV	/	/

Performance parameter

General parameters

Frequency range: receive: 0.5MHz~30MHz
50MHz~54MHz
launch: 160m~6m (Amateur radio band only)

Launch mode: A1A(CW),A3E(AM), J3E(USB/LSB), F3E(FM)

Minimum stepping: 1Hz

Antenna impedance: 50Ω

Working temperature range: -10℃ ~ +50℃

Frequency stability: 1~60minutes after boot is ±4ppm
@25℃: 1ppm/ hour

Supply voltage : Normal: 13.8VDC±15%,Negative grounding
operation: 9.0~15.0VDC,Negative grounding

Current consumption : receive: 600mA@ Max
launch: 2.5A@ Max

Battery capacity : 3800mAh @12V

Fuselage size: 168*93*47mm (WxHxT) (excluding protrusions)

Weight: About 0.94kg (host only)

Transmitter parameters

RF output power: 5W(SSB/CW/FM)1.5W(AM signal carrier) @13.8VDC

Modulation type: SSB: balanced modulation
AM: Low level amplitude modulation
FM: Variable reactance frequency modulation

FM maximum frequency offset: ±5kHz

Stray radiation : -55dB

Carrier suppression : >40dB

Sideband stray: >50dB

SSB frequency response: 400Hz-2800Hz (-6dB)

Microphone impedance: 200~10k (routine 600Ω)

Receiver parameters

Circuit type: Secondary frequency conversion superheterodyne +audio frequency DSP

IF-FRE: First IF:70.455MHz
Second IF:10.695MHz
Third IF:455kHz (NFM)

Sensitivity:

	SSB/CW	AM	FM
≤1.8MHz	0.6uV	10uV	/
1.8MHz-28MHz	0.25uV	2uV	/
28MHz-30MHz	0.25uV	2uV	0.35uV
50MHz-54MHz	0.25uV	2uV	0.35uV

(PRE=on, ATT=off, NB=off, NR=off, SSB/CW/AM = 10dB S/N, FM = 12dB SINAD)

Mirror suppression degree : 70dB

IF Inhibition degree : 60dB

selectivity: SSB: -6dB:2.4kHz/-60dB:4.6kHz
CW: -6dB:500Hz/-60dB:2000Hz
AM: -6dB:6.0kHz/-60dB:25.0kHz
FM: -6dB:12.0kHz/-60dB:25.0kHz

Audio output: 0.6W (8Ω,≤10% THD)

Audio output impedance: 4~16Ω

- ◆ The above specifications may be adjusted without notice.
- ◆ The frequency range of transceiver will vary according to the machine version. Please consult the dealer for details.

Accessories and optional accessories

Standard packing items

Item	Quantity
X5105 Host (installed battery)	1 pcs
Multifunctional hand onamot	1 pcs
power wire	1 pcs
data wire	1 pcs
instructions	1 pcs
Certification	1 pcs
warranty card	1 pcs

Optional accessories

Item	Description
CE-19	ACC extended wiring card
XPA125	120W all-in-one machine of power amplifier and sky modulation

Schematic diagram of connection between existing models and XPA125 of Xiegu Communications

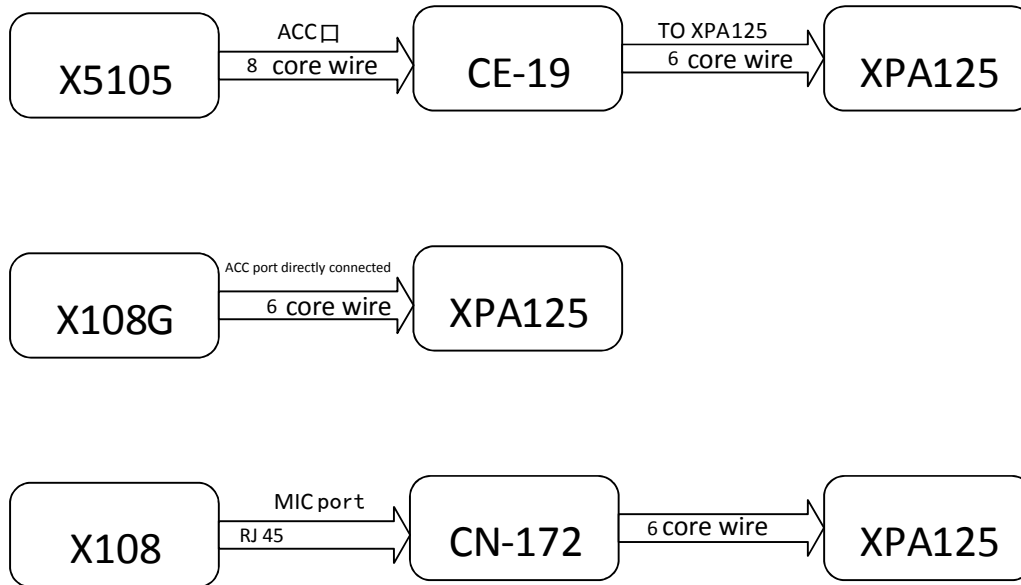

CE-19 Extension Card interface schematic

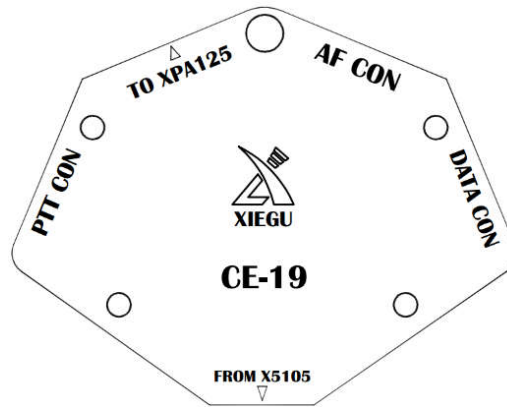

- PTT CON** PTT signal / BAND signal output. This interface PTT signal is completely isolated from the host, providing a "low level" trigger associated with the host.
- TO XPA125** XPA125 power amplifier and sky modulation the all-in-one machine special interface .
- AF CON** Audio input / output. The audio output of this interface is demodulated after direct output, no filter.
- DATA CON** Data output interface in NFM mode. This interface two terminals are parallel relations, both output the same signal.

Copyright Notice

Copyright 2018

Shenzhen Xiegu Communication Technology Co., Ltd. reserves all rights to this manual and shall not copy any part thereof without permission.

1010160203-C



Chongqing Xiegu Technology Co.,Ltd.

www.cqxiegu.com

